



Desportos

Outdoor Fitness • Espaço polidesportivo



Desporto e bem-estar Ao alcance de todos!

Face aos riscos atuais bem conhecidos, associados à falta de atividade física, começam todos a MEXER, em todo o lado! Os responsáveis das coletividades locais e dos parques privados sabem que os equipamentos desportivos ao ar livre, como os complexos Polidesportivos e os espaços Fitness, são investimentos VENCEDORES e aprovados por todos: crianças, adolescentes, adultos e seniores. Ao nível da Husson International, começamos a mexer também, dado que depois de 5 anos de I&D, com concursos de especialistas do desporto e da saúde. Tenho o prazer de apresentar o nosso novo catálogo DESPORTOS que integra as nossas novas linhas de Fitness Out&Fit® e Multisports Color'ado®.

Conceitos inovadores, programas completos acessíveis a um grande número de pessoas, aparelhos com design exclusivo, uma qualidade, uma segurança e uma longevidade com a assinatura das equipas Husson e fabrico francês. Indubitavelmente, Out&Fit® e Color'ado® possuem os benefícios irrefutáveis que permitem que finalmente o Desporto e o Bem-estar estejam ao alcance de todos!

Até breve, no seu campo!

Desportivamente,



Daniel Husson
Presidente
HUSSON International



*"Creio que por vezes o corpo é mais inteligente do que a mente.
É necessário escutá-lo e respeitá-lo..."*

Ashton James Eaton: bicampeão olímpico, bicampeão do mundo, titular do recorde do mundo do **Decatlo**.

Sumário



Out&Fit Gym



Página 16



Out&Fit Stretching



Página 30



Out&Fit Training



Página 36



Out&Fit SWO



Página 46



color' ado

Multisports

Página 56



color' ado

Multisports coberto

Página 72



color' ado

Meeting point

Página 78



Sedentarismo

Os factos:

- Redução preocupante da atividade física, de acordo com a OMS ⁽²⁾: mais de 80% dos adolescentes não fazem atividade física suficiente.
- Desequilíbrio energético entre calorias consumidas e gastas.

Consequências principais

Na saúde:

- Aumento da obesidade ou do excesso de peso.
De acordo com a OMS ⁽²⁾, à escala mundial: 2 mil milhões de pessoas têm excesso de peso ou obesidade (cerca de 40% da população mundial).
- Diabetes, doenças cardiovasculares, artrose, maior taxa de mortalidade, etc.
- Consequências psicológicas (depressão...).
- Discriminação.
- Perda de autonomia.

Outras consequências conhecidas:

- As despesas de saúde e de baixa produtividade induzidas pela “epidemia” mundial de sedentarismo estimam-se estarem, de acordo com os países e os estudos ⁽²⁾, entre 0,4% e + de 1% do PIB.
- Perda de produtividade.
- Pessimismo.

“Physical inactivity is just as dangerous as smoking”

Segundo a revista The Lancet ⁽¹⁾



(1) **The Lancet**: revista científica e médica britânica “A inatividade física é tão perigosa como o tabaco”.
(2) **OCDE**, The Lancet, Morgan Stanley.



Atividade Física e Desportiva

As expetativas (1):

- 60% da população pretende poder fazer mais atividade física.
- 61% pretende praticar uma atividade desportiva ao ar livre e perto de casa.
- 67% da população pretende beneficiar de equipamentos desportivos de livre acesso e abertos a Todos.(1)

As soluções:

A nível local

- Incitar os habitantes das localidades a praticar regularmente uma ou várias atividades físicas e desportivas.
- Desenvolver os equipamentos desportivos nas redondezas bem equipados, tal como os complexos polidesportivos, Fitness ao ar livre.

A nível individual (criança, adolescente, adulto, sénior):

- Ter uma atividade física regular.

Os objetivos esperados:

- Mias saúde, estar em forma.
- Aumento de vida e da qualidade de vida.
- Melhoria do sentimento de bem-estar.
- Reforçar as ligações sociais e intergeracionais.
- Diminuir as despesas públicas associadas à saúde.
- Otimismo.

67%

da população pretende beneficiar de equipamentos desportivos de livre acesso e abertos a Todos.⁽¹⁾



(1) Inquérito BVA Sport 2015 e 2016 sobre os modos e práticas desportivos; Inquérito "Attentes des Seniors" (Expetativas dos Seniores) (Sylver économie) 2014....



Out&Fit

A nova Gama Fitness Outdoor

Out&Fit® é a nova gama Outdoor Fitness desenvolvida pela Husson. As estações e os aparelhos Out&Fit® permitem criar espaços fitness para todos, ao ar livre, em total liberdade, de livre acesso e sob quaisquer condições atmosféricas.

FÁCEIS DE INSTALAR, SIMPLES DE UTILIZAR

Todos os benefícios do desporto e bem-estar ao ar livre e sem os seus inconvenientes graças aos abrigos que protege do sol e da chuva. RESPIRE e aproveite os grandes espaços com **Out&Fit®**.

Um programa fácil, em todo o lado, e que fará mais do que uma pessoa feliz: as estações e aparelhos **Out&Fit®** encontrarão amplamente o seu lugar nos espaços públicos (parques, clubes de desporto, escolas, piscinas...) e privados (clubes de férias, hotéis, campismos...).

*Modelos registados, sistemas patenteados.

CONCEBIDOS PARA TODOS:

Os aparelhos Out&Fit® foram concebidos para serem utilizáveis, em total segurança, por um público amplo:

- Adolescentes, adultos, seniores e pessoas com mobilidade reduzida.
- Mulheres e homens.
- Desportistas iniciantes, profissionais ou experientes.



Out&Fit®, concebido para todos com vários aparelhos acessíveis a pessoas com mobilidade reduzida.

Esses seniores que nos impressionam!



As 3 linhas Out&Fit:

O novo conceito
Out&Fit® propõe
+ de 200 exercícios
de Fitness em 3 espaços
que atuam em sinergia.

Um programa completo
e totalmente adaptado, que
inclui 50 aparelhos para mais de
200 exercícios de musculação,
stretching, equilíbrio e resistência.

Uma ergonomia muito cuidada
desenvolvida por uma equipa de
especialistas do desporto e da
saúde.



REFORÇAR A SUA MUSCULATURA

Out&Fit Gym



MELHORAR A SUA FLEXIBILIDADE

Out&Fit Stretching



DESENVOLVER O SEU EQUILÍBRIO
E RESISTÊNCIA

Out&Fit Training



Out&Fit Gym



FORÇA E TONIFICAÇÃO PARA TODOS

A musculação permite melhorar a sua condição física.

Um corpo mais musculado e mais tonificado é um corpo mais forte, mais resistente, mais sólido e mais equilibrado.

Mas não é possível melhorar a sua forma física sem ...esforço!



Olivier, desportista e fisioterapeuta, 27 anos
"Treino regularmente numa sala, mas o ideal é poder também praticar ao ar livre e neste tipo de equipamentos muito completo."



André, desportista, 41 anos
"Este novo Fitness permite realizar muitos exercícios de musculação ao ar livre. Podem vir várias pessoas e quando quiserem. É muito agradável e além disso, é gratuito!"



Chloé, campeã de França de Ginástica em equipa, 18 anos
"No exterior, é mais motivante. Os aparelhos para abdominais, cadeira romana e trações foram bem pensados e permitem efetivamente reforçar o corpo sem sermos obrigados a ir para uma sala."



Félicie, desportista, 80 anos!
"Gostei muito destes novos equipamentos instalados no parque de l'Orangerie em Strasbourg. Pierre, o fisioterapeuta, que lá estava, no dia da inauguração, explicou-me bem os exercícios e estou contente por ter conseguido fazer a cadeiraromana!"



Timothée, ginasta e breakdancer, 21 anos
"Com estas correias de suspensão, podemos praticar no exterior vários exercícios fundamentais como os Fly, os Chest Press, os Biceps Curl ou os Squats e, além disso, é divertido. Até encontrei outros exercícios que não estão mencionados nos painéis."



Out&Fit® Gym FORÇA E TONIFICAÇÃO PARA TODOS

Número impressionante ⁽¹⁾, 80% das lombalgias são causadas por uma fraqueza muscular. Daí a importância de fazer regularmente exercícios de “reforço muscular”, que consistem no reforço da sua musculatura profunda, os músculos abdominais, lombares e dorsais, que envolvem a coluna vertebral. A partir de agora, com os espaços **Out&Fit® Gym**, é possível melhorar as suas qualidades físicas e a sua saúde, em total liberdade, ao ar livre e sob quaisquer condições atmosféricas. Concebidos por especialistas do desporto e da saúde, os aparelhos **Out&Fit® Gym** são eficientes, ergonómicos e lúdicos ao mesmo tempo, estão acessíveis a todos, mulheres e homens, adolescentes, adultos e seniores, desportistas iniciantes, profissionais e experientes, e muito apreciados por todos. O programa **Out&Fit® Gym** é muito completo e motivante, os exercícios são intuitivos e atrativos.

Graças a uma dúzia de aparelhos, é possível praticar em excelentes condições, mais de 140 exercícios para reforçar os seus principais grupos musculares. Outros exercícios e programas de treino elaborados pelos nossos Coachs poderão brevemente ser transferidos.

(1) Fonte: Didier Reiss e o Doutor Pascal Prévost “Le guide scientifique et pratique pour tous”.

Como funciona?

Os principais aparelhos e exercícios **Out&Fit®** são intuitivos e não requerem qualquer experiência. Um painel de informações gerais fornece os principais conselhos de utilização, enquanto são especificadas instruções específicas em cada aparelho (benefícios e dificuldade dos exercícios, etc.).

Um código QR e uma aplicação gratuita poderão brevemente ser transferidos. Permitem visualizar online os exercícios, programas de treino e **conselhos dos nossos Coachs**.



FÁCIL



MÉDIO



DIFÍCIL

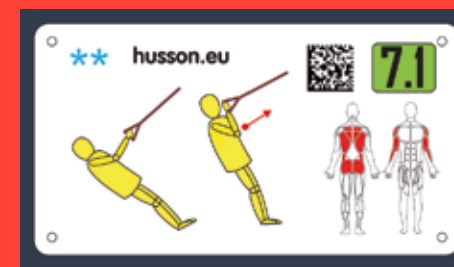

Out&Fit Stretching



DESCONTRAIA

O termo inglês "stretching" significa "alongar". O corpo humano precisa de alongar: fazemo-lo um pouco de manhã ao acordar e gostaríamos de o fazer ao levantarmo-nos de uma cadeira após uma longa reunião!



Out&Fit® Stretching

DESCONTRAIA

Out&Fit Stretching



O "stretching" é dirigido aos desportistas mais ou menos profissionais e as "flexões" são dirigidas a TODOS!
A flexão é um movimento suave, que vai até às possibilidades permitidas sem forçar nada e sem dores.

Os benefícios do Stretching são numerosos:

- **Aumenta a flexibilidade** e a elasticidade dos seus músculos e tendões.
- **Combate os efeitos do envelhecimento:**
um programa de stretching ajuda a recuperar flexibilidade e a melhorar a amplitude de movimentos das suas articulações.
- **Prepara o seu corpo antes do esforço.**
- **Limita os riscos de lesões durante o esforço:**
um músculo flexível é muito mais resistente do que um músculo endurecido.
- **Ajuda a recuperar mais rapidamente a flexibilidade após o esforço.**
- **Alivia o stress:** os alongamentos relaxam os músculos tensos que estão normalmente associados ao stress.
- **Ajuda a descontrair** para ganhar bem-estar e relaxamento.

A partir de agora, com os espaços Out&Fit® Stretching, os benefícios do stretching são possíveis, ao ar livre, de livre acesso e para todos: mulheres e homens, adultos e seniores, pessoas com mobilidade reduzida...

Out&Fit® Stretching é um programa muito completo, que permite **uma prática orientada e motivante** com mais de 25 exercícios de alongamento mais benéficos para preservar e melhorar a sua saúde.

Os exercícios de alongamento são agrupados numa estação **Out&Fit® Stretching** inovadora* e **um banco com design exclusivo***; são fáceis, pedagógicos e lúdicos.

O Out&Fit® Stretching é único*.

Ajuda a libertar as tensões e convida a tomar conta de si, para se sentir melhor, tanto a nível físico como psicológico.

*Modelos registados, sistemas patenteados.



Out&Fit Training



EQUILÍBRIO E RESISTÊNCIA

Com a linha Out&Fit® Training de Husson, poderá melhorar de forma lúdica, a sua condição física e o seu equilíbrio.



Out&Fit Training



Out&Fit® Training EQUILÍBRIO E RESISTÊNCIA

Denominados igualmente cardio-training, a linha Out&Fit® Training associa uma atividade muscular e cardiovascular que permite fazer trabalhar o conjunto do organismo.

Acessível a um grande número de pessoas, o programa propõe vários exercícios nos aparelhos exclusivos: Ski-Training, Bicicleta, Hand-cycle, Skate-Training, Discos giratórios, Twister, Percursos de obstáculos.

*Modelos registados



VERSÃO COBERTURA, TEMA SPORT



VERSÃO SEM COBERTURA, TEMA PARK

Out&Fit®

AS MELHORES TÉCNICAS

- **Um conceito inovador:**

Um design novo e exclusivo* com 3 linhas (Gym, Stretching, Training), 2 versões (com ou sem cobertura) e 3 temas (**Park, Sport, Urban**).

- **Ergonomia e dimensões:**

As ilhas e aparelhos **Out&Fit®** foram concebidos para desenvolver uma ergonomia muito cuidada que permite a todos, uma prática desportiva e de descontração ao ar livre, em condições de conforto ideais.

- **Segurança:**

Os aparelhos **Out&Fit®** foram estudados de acordo com especificações rigorosas que integram as exigências da nova norma europeia EN 16630; em seguida, foram testados e validados por um laboratório independente. São destinados aos adultos e adolescentes a partir dos 14 anos.

- **Uma garantia de longa duração de 10 anos:**

Peças garantidas: armação e aparelhos metálicos não móveis, painéis em HPL.

Condições de aplicação das garantias HUSSON: consultar as condições gerais de venda HUSSON (nas últimas páginas da tarifa em vigor).

- **O incentivo do desenvolvimento sustentável:**

- As formas, os temas, as cores, a transparência dos equipamentos permitem integrar harmoniosamente equipamentos **Out&Fit®** em todos os meios-ambientes.

- Os materiais e revestimentos de superfície utilizados são inertes ecologicamente, ou seja, respeitam a natureza durante todo o tempo de vida e são, em seguida, facilmente recicláveis como o aço.

- Os equipamentos HUSSON são reconhecidos pela sua grande longevidade, pois também é isso o desenvolvimento sustentável!

- **Uma manutenção simples e muito económica:**

A utilização do inox, do aço (revestido de um duplo revestimento de superfície excepcional) e de um sistema de montagem único* (comum ao conjunto das gamas HUSSON) permite uma manutenção muito simples e particularmente económica.

*Modelos registados, sistemas patenteados





Out&Fit®

AS MELHORES TÉCNICAS

Materiais de alta qualidade

- 1 Armação/Estrutura:**
postes em aço galvanizado e termolacado (diâmetro 89 mm esp. 3 mm).
- 2 Aparelhos:**
em inox passivado após fabrico.
- 3 Outros aparelhos:**
em aço galvanizado a quente e termolacado com acabamento de textura fina para uma boa "preensão" e uma excelente resistência ao risco e à abrasão.
- 4 Coberturas:**
em termoplástico rotomoldado HDPE (High Density Polyethylene) de espessura muito robusta, pintado na massa e reforçado por uma armação tubular em aço. Parte central transparente em policarbonato antichoque.
- 5 Chapas:**
cortadas a laser, em aço galvanizado e termolacado.

VERSÃO COBERTURA, TEMA URBAN





Out&Fit Gym JFI-0101



Número de utilizadores

6



Número de aparelhos

6



Exercícios principais

16



Exercícios adicionais Coaching Connect

>32



Total exercícios

>48



Vista B



Vista A

G1 ★★ ▶ ★★★ 1 2 >2	G2 ★ ▶ ★★★ 1 3 >2	G3 ★ ▶ ★★★ 0 3 >2	G4 ★★ 0 1 >1	G5 ★★★ 0 2 >2	G6 ★★★ 0 2 >4	G7 ★★ 1 2 >12	G8 ★ 1 3 >10	G9 ★ ▶ ★★★ 0 6 >25	G10 ★ ▶ ★★★ 1 3 0	G11 ★★ 1 3 >6	G12 ★★ 1 3 >6
Abdominais	Push-Up	Cadeira Romana	Lombar	Trações	Multitrações	Correias OFX Parte superior Corpo	Correias OFX Parte inferior Corpo	Multicorreias OFX	Hand Challenge	Box	Step



JFI0101



14+



3854 x 2804 x 2759 mm



6653 x 6421 mm



30 m²



1,0 m



4h



2



+00
7

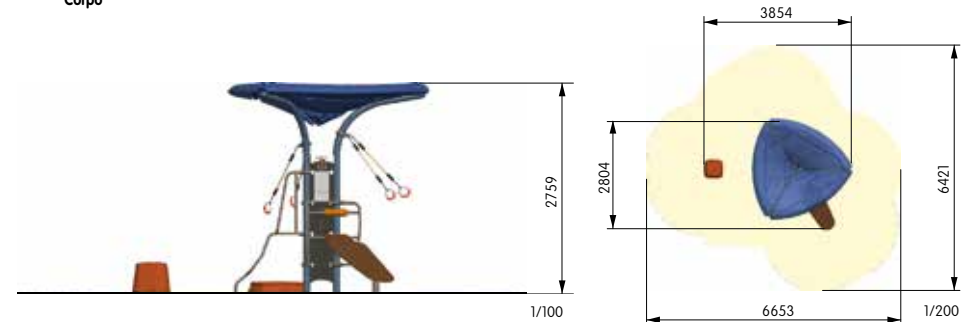



Out&Fit Gym JFI-0101



Uma configuração **Out&Fit Gym** compacta, destinada a todos, dos iniciantes aos experientes, ideal para o treino individual ou em pequenos grupos.
Para 6 utilizadores e com mais de 48 exercícios.

Outros temas, cores e aparelhos:
consultar as páginas de apresentação **Out&Fit Gym** e peça conselhos ao seu responsável regional.

Out&Fit Gym JFI-0801







 Número de utilizadores 8	 Número de aparelhos 8	 Exercícios principais 18	 Exercícios adicionais Coaching Connect >38	 Total exercícios >56
---	--	---	--	--





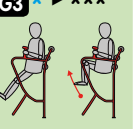
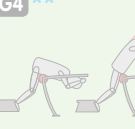
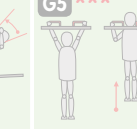
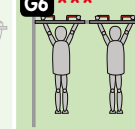



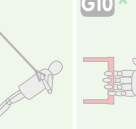
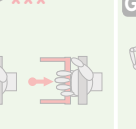



Vista B



Vista A

G1 ★★ ▶ ★★★  1 2 >2	G2 ★ ▶ ★★★  1 3 >2	G3 ★ ▶ ★★★  0 3 >2	G4 ★★  1 1 >1	G5 ★★★  0 2 >2	G6 ★★★  2 2 >4	G7 ★★  1 2 >12	G8 ★  1 3 >10	G9 ★ ▶ ★★★  0 6 >25	G10 ★ ▶ ★★★  0 3 0	G11 ★★  1 3 >6	G12 ★★  1 3 6
Abdominais	Push-Up	Cadeira Romana	Lombares	Trações	Multitrações	Correias OFX Parte superior Corpo	Correias OFX Parte inferior Corpo	Multicorreias OFX	Hand Challenge	Box	Step

	 JFI0801		 14+	 1 2 3 7907 x 3250 x 2750 mm	 9152 x 6421 mm	 39 m ²	 1,0 m	 5h	 2	 +00 11
---	---	---	---	--	--	---	---	--	--	---

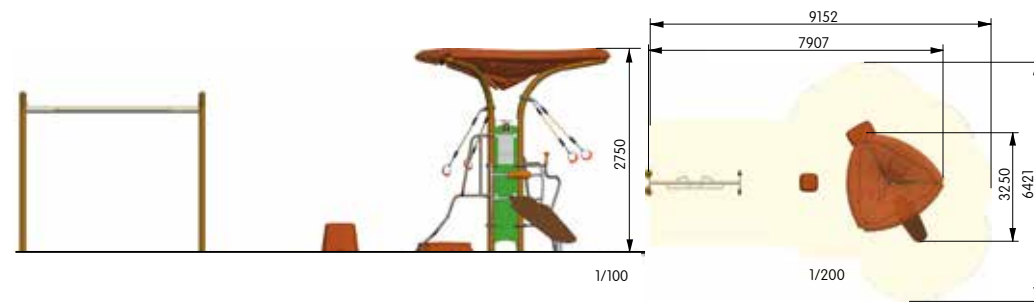



Out&Fit Gym JFI-0801













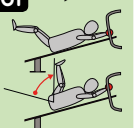



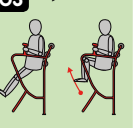

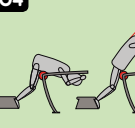
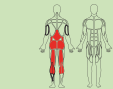
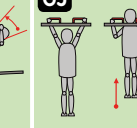

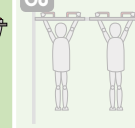
Uma configuração **Out&Fit** Gym muito completa, com um módulo adicional G6 "Multi-Tractions", muito apreciado pelos desportistas e com uma parte abrigada. Para 8 utilizadores e com mais de 56 exercícios.

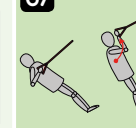
Outros temas, cores e aparelhos: consultar as páginas de apresentação **Out&Fit** Gym e peça conselhos ao seu responsável regional.

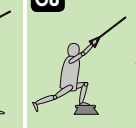
Out&Fit Gym JFI-0201

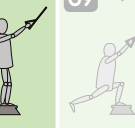
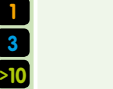
 Número de utilizadores 10	 Número de aparelhos 10	 Exercícios principais 25	 Exercícios adicionais Coaching Connect >43	 Total exercícios >68
--	---	---	--	--

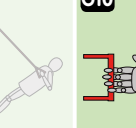
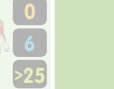
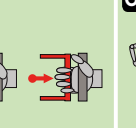

G1 ★★ ▶ ★★★   1 2 >2 Abdominais	G2 ★ ▶ ★★★   1 3 >2 Push-Up	G3 ★ ▶ ★★★   1 3 >2 Cadeira Romana	G4 ★★   1 1 >1 Lombares	G5 ★★★   1 2 >2 Trações	G6 ★★★   0 2 >4 Multitrações	G7 ★★   1 2 >12 Correias OFX Parte superior Corpo	G8 ★   1 3 >10 Correias OFX Parte inferior Corpo	G9 ★ ▶ ★★★   0 6 >25 Multicorreias OFX	G10 ★ ▶ ★★★   1 3 0 Hand Challenge	G11 ★★   1 3 >6 Box	G12 ★★   1 3 >6 Step
---	---	--	---	---	--	--	--	--	---	---	--

										
JFI0201			14+	5237 x 4407 x 2908 mm	8283 x 7484 mm	48 m ²	1,0 m	8h	2	14

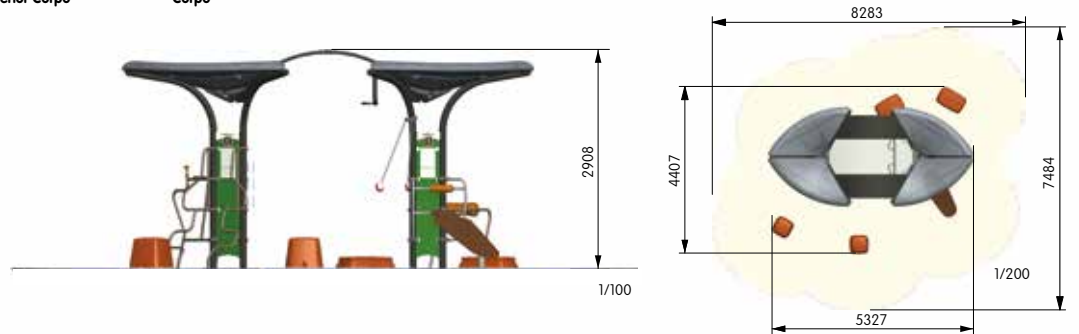



Uma configuração **Out&Fit Gym** muito completa e lúdica, destinada a todos, dos iniciantes aos experientes, ideal para o treino individual ou em pequenos grupos. Para 10 utilizadores e com mais de 68 exercícios.

Outros temas, cores e aparelhos: consultar as páginas de apresentação **Out&Fit Gym** e peça conselhos ao seu responsável regional.









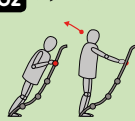
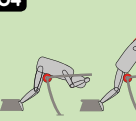
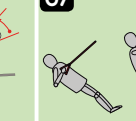
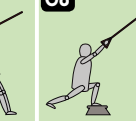
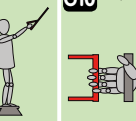
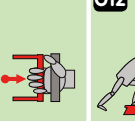

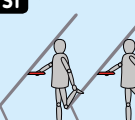
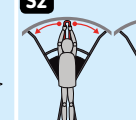
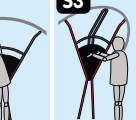
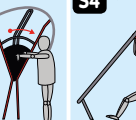
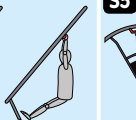
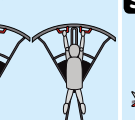



Out&Fit Gym JFI-0202

 Número de utilizadores 13	 Número de aparelhos 13	 Exercícios principais 28	 Exercícios adicionais Coaching Connect >43	 Total exercícios >71
--	---	---	--	--



G2 * >***  1 3 >2 Push-Up	G4 **  1 1 >1 Lombares	G7 **  1 2 >12 Correas OFX Parte superior Corpo	G8 *  1 3 >10 Correas OFX Parte inferior Corpo	G10 >***  1 3 >0 Hand Challenge	G12 **  1 3 >6 Step
--	---	--	---	--	---

S1 *  1 4 >3 Double Arche	S2 *  1 3 >3 Pêndulo	S3 *  1 1 >2 Muro	S4 *  1 1 >1 Suspensão Baixa	S5 **  1 1 >1 Suspensão Alta	S6 *  1 2 >1 Plano	S7 *  1 1 >1 Banquinho
---	--	---	--	--	---	--

	 JFI0202		 14+	 1 2 3 5418 x 3987 x 2908 mm	 7932 x 7122 mm	 44 m ²	 1,0 m	 8h	 2	 +00 14
---	---	---	---	--	--	---	---	--	---	---

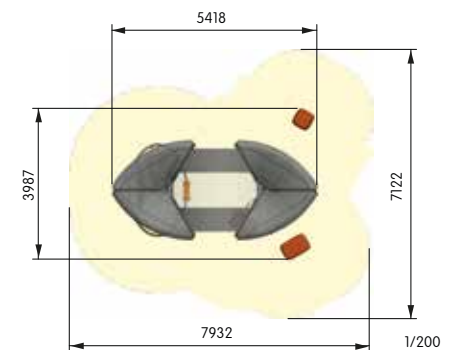



Out&Fit Gym JFI-0202



Uma configuração **Out&Fit Gym** muito completa, com um módulo adicional G6 "Multi-Tractions", muito apreciado pelos desportistas e com uma parte abrigada. Para 13 utilizadores e com mais de 71 exercícios.

Outros temas, cores e aparelhos: consultar as páginas de apresentação **Out&Fit Gym** e peça conselhos ao seu responsável regional.



Out&Fit Gym JFI-0308

Número de utilizadores	Número de aparelhos	Exercícios principais	Exercícios adicionais Coaching Connect	Total exercícios
8	8	18	>42	>60



Vista B

Vista A

G1 ★★ ▶ ★★★ 1 2 >2	G2 ★ ▶ ★★★ 1 3 >2	G3 ★ ▶ ★★★ 0 3 >2	G4 ★★ 0 1 >1	G5 ★★★ 0 2 >2	G6 ★★★ 2 2 >4	G7 ★★ 1 2 >12	G8 ★ 1 3 >10	G9 ★ ▶ ★★★ 0 6 >25	G10 ★ ▶ ★★★ 0 3 0	G11 ★★ 1 3 >6	G12 ★★ 1 3 >6
Abdominais	Push-Up	Cadeira Romana	Lombares	Trações	Multitrações	Correias OFX Parte superior Corpo	Correias OFX Parte inferior Corpo	Multicorreias OFX	Hand Challenge	Box	Step

JFI0308		14+	6346 x 3920 x 2203 mm	9351 x 6998 mm	42 m ²	1,0 m	4h	2	+00	8

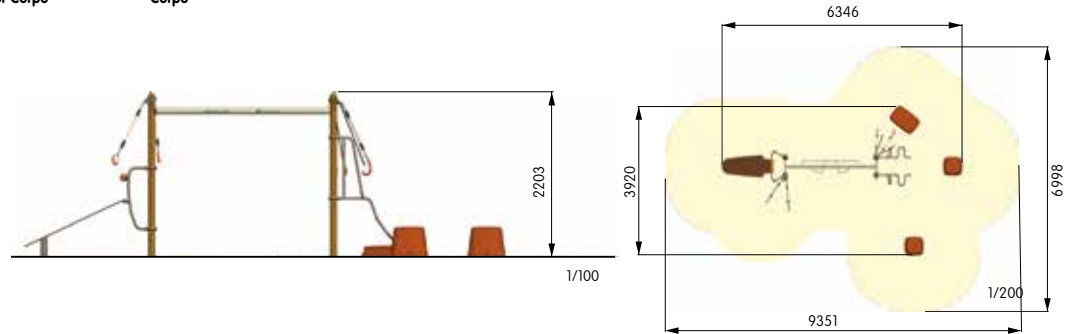



Out&Fit Gym JFI-0308













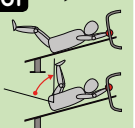



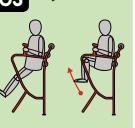

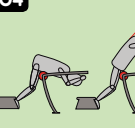

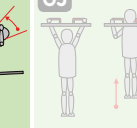

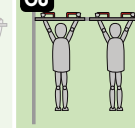
Uma configuração **Out&Fit Gym** compacta e completa. Para 8 utilizadores e com mais de 60 exercícios.

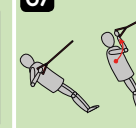

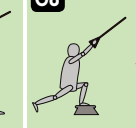

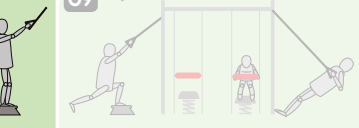
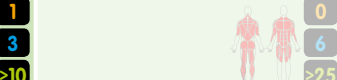
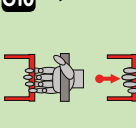
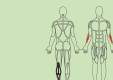
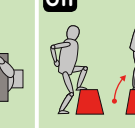

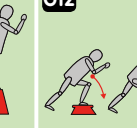



Outros temas, cores e aparelhos: consultar as páginas de apresentação **Out&Fit Gym** e peça conselhos ao seu responsável regional.

Out&Fit Gym JFI-0301

 Número de utilizadores 11	 Número de aparelhos 11	 Exercícios principais 25	 Exercícios adicionais Coaching Connect >45	 Total exercícios >70
--	---	---	--	--



G1 ★★ ▶ ★★★   1 2 >2 Abdominais	G2 ★ ▶ ★★★   1 3 >2 Push-Up	G3 ★ ▶ ★★★   1 3 >2 Cadeira Romana	G4 ★★   1 1 >1 Lombares	G5 ★★★   0 2 >2 Trações	G6 ★★★   2 2 >4 Multitrações	G7 ★★   1 2 >12 Correias OFX Parte superior Corpo	G8 ★   1 3 >10 Correias OFX Parte inferior Corpo	G9 ★ ▶ ★★★   0 6 >25 Multicorreias OFX	G10 ★ ▶ ★★★   1 3 0 Hand Challenge	G11 ★★   1 3 >6 Box	G12 ★★   1 3 >6 Step
---	---	--	---	---	--	--	--	--	---	---	--

										
JFI0301	14+	7508 x 5014 x 2203 mm	10 522 x 8031 mm	58 m²	1,0 m	6h	2	12		

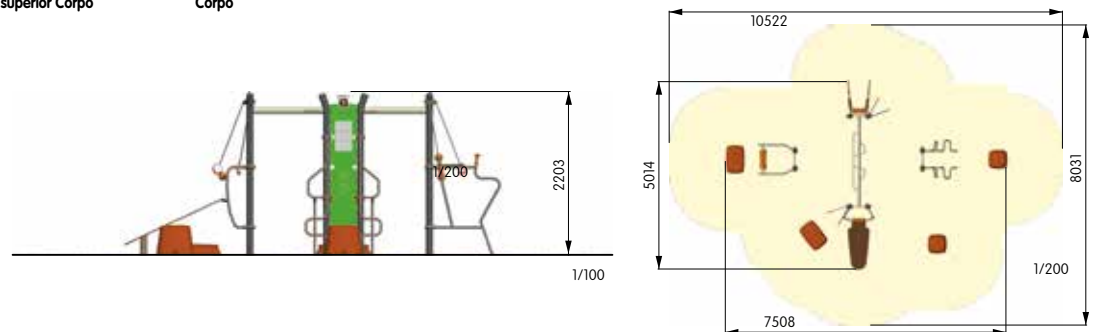



Out&Fit Gym JFI-0301



Uma configuração **Out&Fit Gym** compacta e muito completa. Para 11 utilizadores e com mais de 70 exercícios.

Outros temas, cores e aparelhos:







consultar as páginas de apresentação **Out&Fit Gym** e peça conselhos ao seu responsável regional.

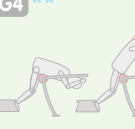
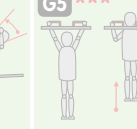
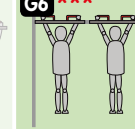

Out&Fit Gym JFI-0802

 Número de utilizadores 10	 Número de aparelhos 10	 Exercícios principais 14	 Exercícios adicionais Coaching Connect >41	 Total exercícios >55
--	---	---	--	--

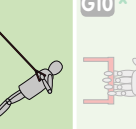
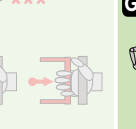

G1 ★★ ▶ ★★★  0 2 >2 Abdominais	G2 ★ ▶ ★★★  0 3 >2 Push-Up	G3 ★ ▶ ★★★  0 3 >2 Cadeira Romana	G4 ★★  0 1 >1 Lombares	G5 ★★★  0 2 >2 Trações	G6 ★★★  2 2 >4 Multicorreas	G7 ★★  0 2 >12 Correias OFX Parte superior Corpo	G8 ★  0 3 >10 Correias OFX Parte inferior Corpo	G9 ★ ▶ ★★★  6 6 >25 Multicorreas OFX	G10 ★ ▶ ★★★  0 3 0 Hand Challenge	G11 ★★  1 3 >6 Box	G12 ★★  1 3 >6 Step
--	--	---	--	--	---	---	---	--	---	--	---

	 JFI0802		 14+	 8369 x 3359 x 2198 mm	 9906 x 6900 mm	 49 m ²	 1,0 m	 4h	 2	 +00 14
---	--	---	--	--	---	--	--	---	--	--

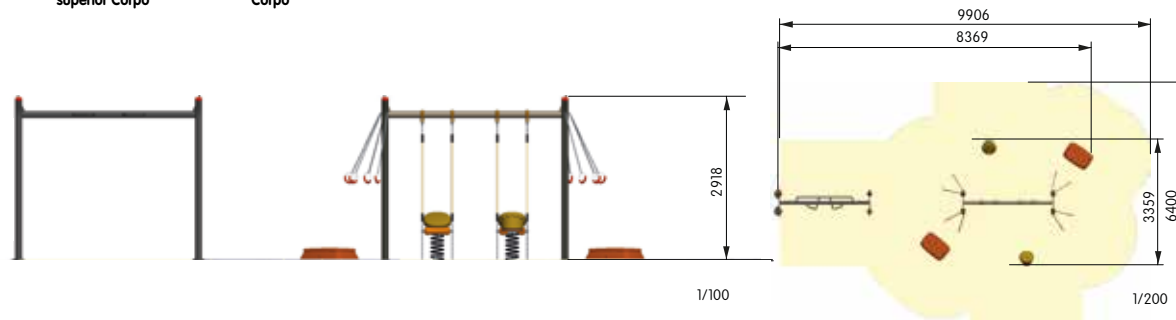













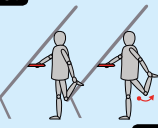

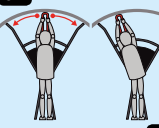

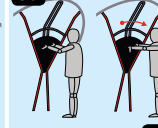
Uma configuração **Out&Fit** Gym compacta e completa, com um módulo G6 "Multi-Tractions" e um conjunto G9 "Multicorreias OFX" que oferecem vários exercícios de reforço muscular "Parte superior do corpo" e "Parte inferior do corpo". Para 10 utilizadores e com mais de 55 exercícios.

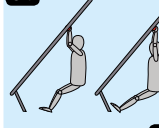
Outros temas, cores e aparelhos: consultar as páginas de apresentação **Out&Fit** Gym e peça conselhos ao seu responsável regional.

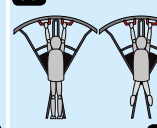



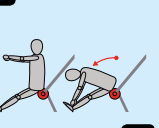



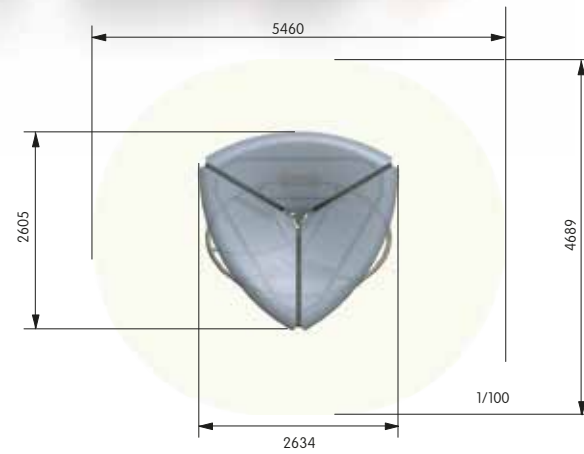

Out&Fit Stretching JFI-0501

 Número de utilizadores 7	 Número de aparelhos 7	 Exercícios principais 13	 Exercícios adicionais Coaching Connect >12	 Total exercícios >25
---	--	---	--	--



S1*   1 4 >3 Double Arche	S2*   1 3 >3 Pêndulo	S3*   1 1 >2 Muro	S4*   1 1 >1 Suspensão Baixa	S5**   1 1 >1 Suspensão Alta	S6*   1 2 >1 Plano	S7*   1 1 >1 Banquinho
---	--	---	--	--	--	--



	 JFI0501		 14+	 2634 x 2605 x 2759 mm	 5460 x 4689 mm	 21 m ²	 1,0 m	 4h	 2	 +00 8
---	--	---	--	--	---	--	--	---	--	---



Uma estação **Out&Fit** Stretching compacta e abrigada, que reúne mais de 25 exercícios fáceis e lúdicos. De forma pedagógica, permite alongar e fletir os principais músculos do corpo, desenvolver a sua flexibilidade, mas também melhorar a rigidez e outras dores crônicas. Até 7 utilizadores.

Outros temas, cores e aparelhos:

consultar as páginas de apresentação **Out&Fit** Stretching e peça conselhos ao seu responsável regional.



Out&Fit Stretching JFI-0601



 Número de utilizadores 7	 Número de aparelhos 7	 Exercícios principais 13	 Exercícios adicionais Coaching Connect >12	 Total exercícios >25
---	--	---	---	--







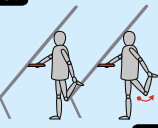
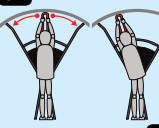
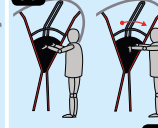
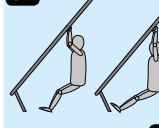
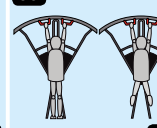

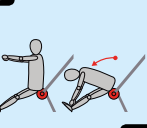



Vista B



Vista A

S1*  1 4 >3 Double Arche	S2*  1 3 >3 Pêndulo	S3*  1 1 >2 Muro	S4*  1 1 >1 Suspensão Baixa	S5**  1 1 >1 Suspensão Alta	S6*  1 2 >1 Plano	S7*  1 1 >1 Banquinho
--	---	--	---	---	---	---

	 JFI0601		 14+	 2456 x 1678 x 2234 mm	 5460 x 4689 mm	 21 m ²	 1,0 m	 2h	 2	 +00 7
---	--	---	--	--	---	--	--	---	--	---

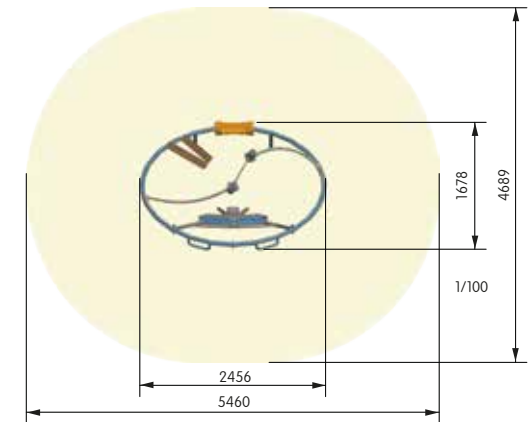
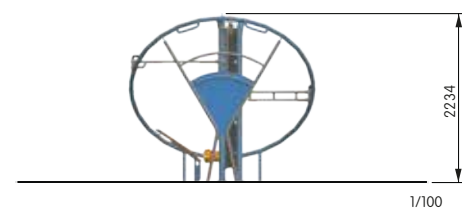



Out&Fit Stretching

JFI-0601



Uma estação Out&Fit Stretching compacta que reúne mais de 25 exercícios fáceis e lúdicos. De modo pedagógico, permite alongar e fletir os principais músculos do corpo, desenvolver a sua flexibilidade, mas também melhorar a rigidez e outras dores crónicas. Até 7 utilizadores.









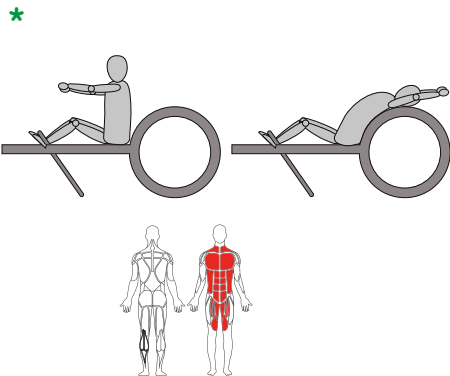

Outros temas, cores e aparelhos:
consultar as páginas de apresentação
Out&Fit Stretching e pedir conselhos ao seu responsável regional.



Out&Fit Stretching JFI-0701 O Banco "Chave Stretching"

 Número de utilizadores	 Número de aparelhos	 Exercícios principais	 Exercícios adicionais Coaching Connect	 Total exercícios
1	1	6	>4	>10



	 JFI0701		 14+	 2424 x 391 x 960 mm	 5426 x 3391 mm	 17 m ²	 1,0 m	 1h	 2	 +00 2
---	--	---	--	--	---	--	--	---	--	---

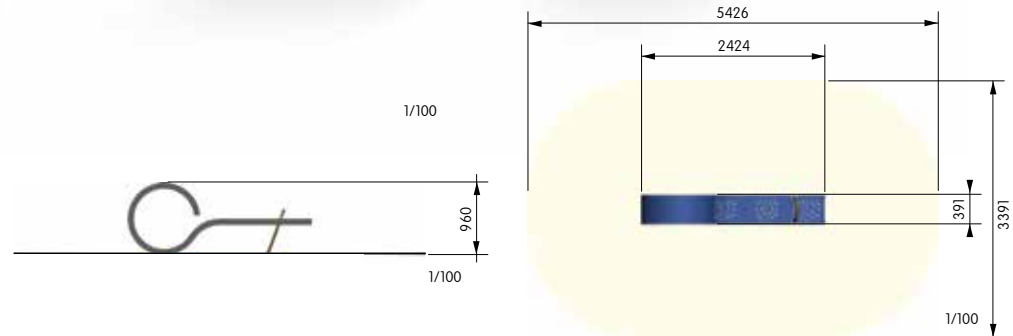



O Banco **Out&Fit** Stretching com design exclusivo, oferece-lhe uma dezena de exercícios de flexões e alongamentos mais benéficos.

Permite igualmente descansar e ...relaxar!
Para 1 a 2 utilizadores e com mais de 10 exercícios.

Outros temas, cores e aparelhos:
consultar as páginas de apresentação
Out&Fit Stretching e pedir conselhos
ao seu responsável regional.



Out&Fit Training JFI-0901 O Ski-Training



Número de utilizadores

1



Número de aparelhos

1



Exercícios principais

3



Exercícios adicionais Coaching Connect

>2



Total exercícios

>5

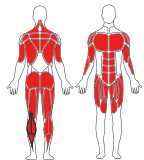

JFI0901



14+



2338 x 555 x 1668 mm

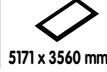

5171 x 3560 mm



17 m²



1,0 m



1h



2



+00 2

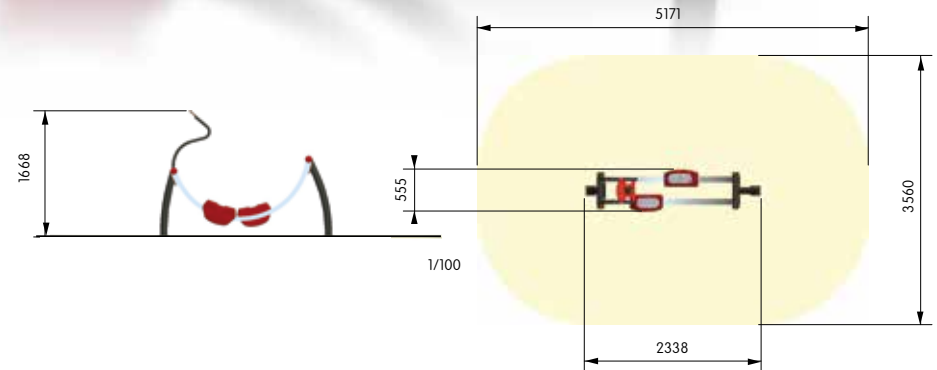



Out&Fit Training JFI-0901



Le Ski-Training* Out&Fit® é um aparelho excelente que permite a um grande número de pessoas, melhorar a sua condição física de forma lúdica e motivante.

Multifunções, propõe 3 exercícios diferentes para reforçar os principais músculos dos membros inferiores e a parte superior do corpo.

O Ski-Training* Out&Fit® permite-lhe melhorar as suas capacidades cardiovasculares e de resistência, queimar calorias, desenvolver o equilíbrio e a coordenação.

Um dispositivo exclusivo* HUSSON de calhas e rolamento em inox garante uma manutenção simples e económica.

A qualidade, solidez, durabilidade e segurança com assinatura HUSSON.

Para 1 utilizador.

*modelos registados



Out&Fit Training JFI-0906 A Bicicleta

Número de utilizadores	Número de aparelhos	Exercícios principais	Exercícios adicionais Coaching Connect	Total exercícios
1	1	1	>0	>1



*

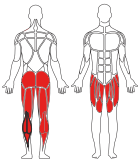

JFI0906		14+	1120 x 704 x 890 mm	4120 x 3705 mm	14 m ²	1,0 m	1h	1	2

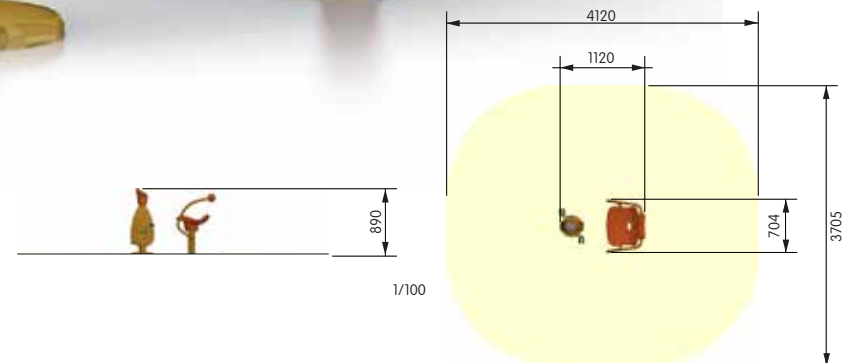



Out&Fit Training JFI-0906



A **Bicicleta Out&Fit®** é um aparelho excelente que permite a um grande número de pessoas, melhorar a sua condição física de forma lúdica e motivante.

A **Bicicleta Out&Fit®** está equipada com um dispositivo exclusivo de resistência por eletroímã para uma prática desportiva ideal (quanto mais depressa pedalar, maior resistência oferece o mecanismo) . O modelo de base (ref. JFI-0906) está equipado com um local para smartphone. Um modelo com carregamento de smartphones é proposto pela HUSSON (ref. JFI-0907): graças à energia produzida pela pedalagem, agora já pode carregar o seu telemóvel! A ergonomia foi especificamente cuidada para uma prática confortável e segura (excelente apoio das costas). A qualidade, solidez, durabilidade e segurança com assinatura HUSSON.



Out&Fit Training JFI-0905 O Hand Cycle

Número de utilizadores	Número de aparelhos	Exercícios principais	Exercícios adicionais Coaching Connect	Total exercícios
1	1	1	>0	>1



*

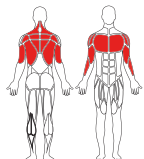
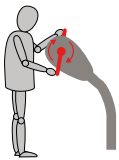

JFI0905			14+	755 x 404 x 1164 mm	3654 x 3089 mm	10 m²	1,0 m	1h	1	1

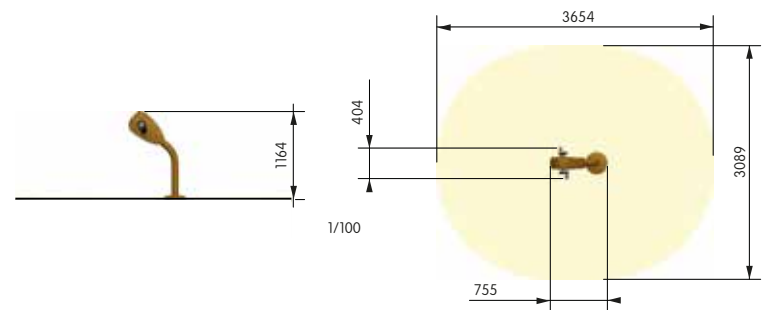



A Bicicleta Out&Fit® é um aparelho excelente que permite a um grande número de pessoas, melhorar a sua condição física de forma lúdica e motivante.

A Bicicleta Out&Fit® está equipada com um dispositivo exclusivo de resistência por eletroímã para uma prática desportiva ideal (quanto mais depressa pedalar, maior resistência oferece o mecanismo).

A qualidade, solidez, durabilidade e segurança com assinatura HUSSON.

Para 1 utilizador.











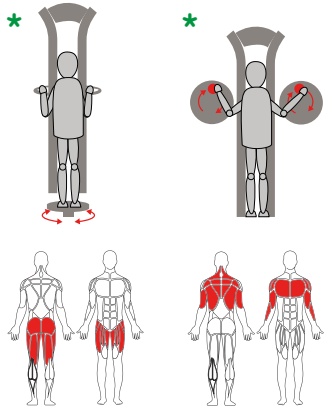



Out&Fit Training JFI-0905



Out&Fit Training JFI-0908 O Duo Twister e Discos giratórios

 Número de utilizadores	 Número de aparelhos	 Exercícios principais	 Exercícios adicionais Coaching Connect	 Total exercícios
2	2	3	>1	>4



										
JFI0908			14+	1439 x 1083 x 2180 mm	4437 x 4096 mm	15 m²	1,0 m	1h	2	3

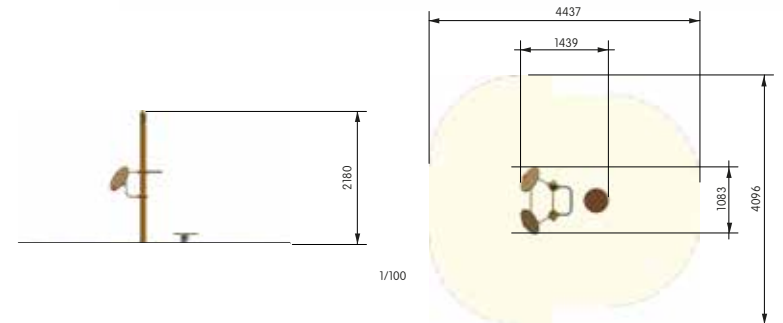



O Duo Twister e Discos giratórios Out&Fit

É o aparelho Fitness ideal para Todos e, nomeadamente, para os seniores. O módulo Discos giratórios permite melhorar a coordenação e a flexibilidade das articulações (ombros, cotovelos, punhos e dedos). O módulo Twister é o exercício ideal para recuperar confiança. Permite reforçar os músculos da parte inferior do corpo e da bacia. Para 2 utilizadores.

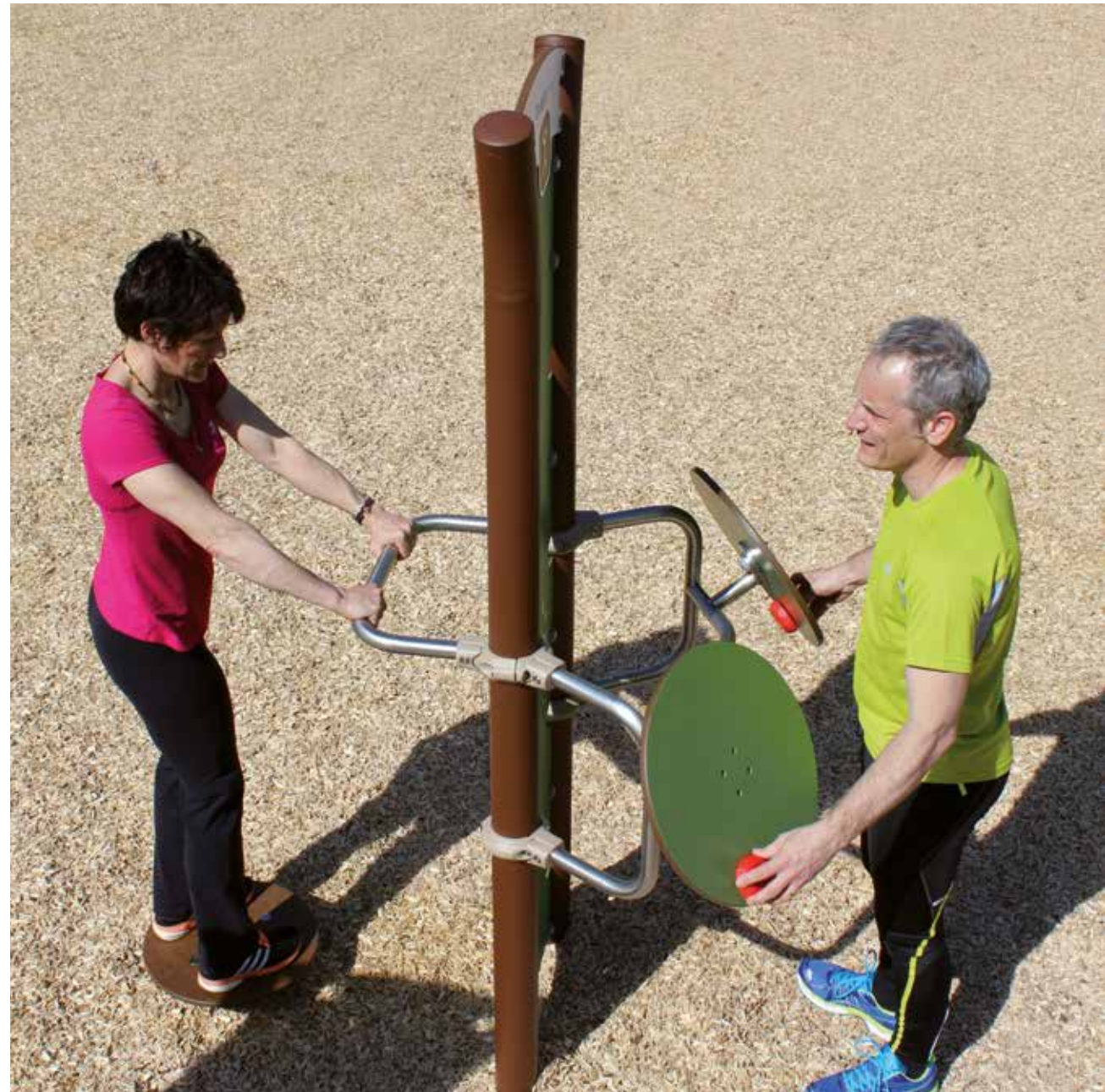

Out&Fit Training JFI-0909 Up & Down

 Número de utilizadores	 Número de aparelhos	 Exercícios principais	 Exercícios adicionais Coaching Connect	 Total exercícios
1	1	1	>0	>1

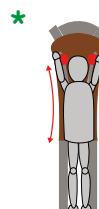









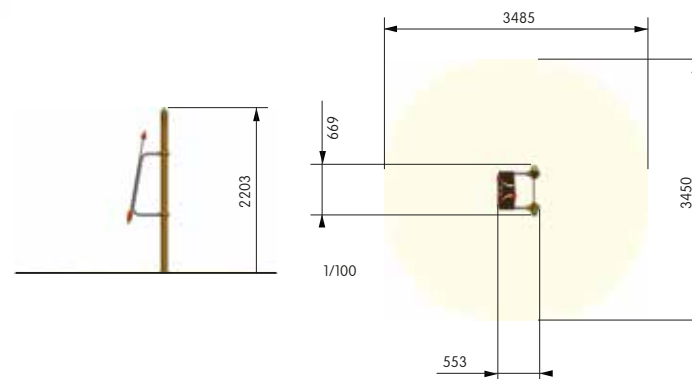
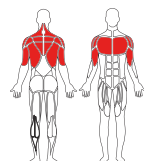



O Up & Down Out&Fit

foi especialmente concebido por um fisioterapeuta destinado a seniores que sofrem de "rigidez" ou "de anquilose dos ombros".

Permite melhorar de forma agradável e eficaz a flexibilidade e a amplitude das articulações, sem qualquer risco de lesões.

Para 1 utilizador.



	 JFI0909		 14+	 1 2 3 553 x 699 x 2203 mm	 3485 x 3450 mm	 11 m ²	 1,0 m	 1h	 2	 +00 2
---	---	---	---	--	--	---	---	--	---	---



Out&Fit Training JFI-0910



Número de utilizadores

1



Número de aparelhos

1



Exercícios principais

1



Exercícios adicionais Coaching Connect

>0



Total exercícios

>1

O caminho de pedras



*

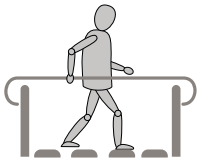

O caminho de pedras Out&Fit

foi concebido para devolver a confiança aos seniores mais idosos que, por vezes, têm medo de cair.

Graças a este aparelho, podem treinar e melhorar o equilíbrio, agilidade, em total segurança

Para 1 utilizador.

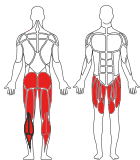

JFI0910



14+



2800 x 690 x 980 mm

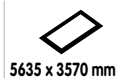

5635 x 3570 mm



18 m²



1,0 m



2h



2



+00 9

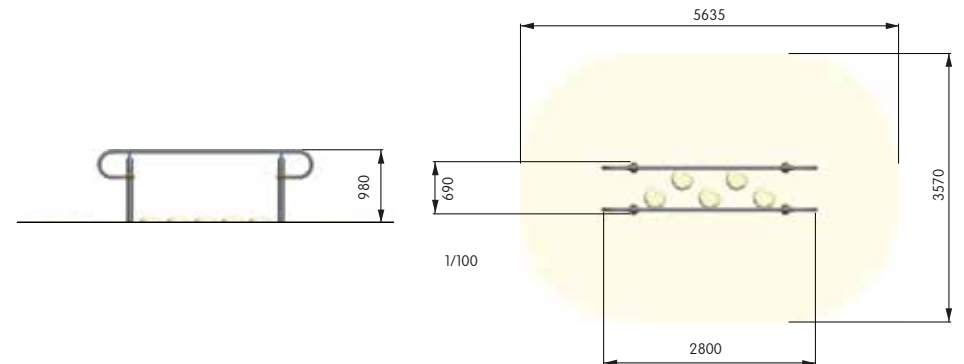

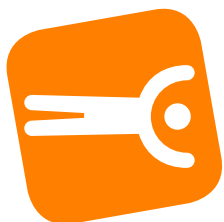

FORÇA, EQUILÍBRIO E DOMÍNIO CORPORAL

As **origens do Street Workout**, igualmente denominado "**Street Gym**" ou "**Calistenia**" devem remontar aos Jogos Olímpicos da **Grécia Antiga**. **Calistenia** vem das palavras gregas "Kallos" (beleza) e "Stenos" (força).

Atualmente, o Street Workout é uma aula de Fitness geralmente praticada ao ar livre, em total liberdade e que associa **Musculação ao peso do corpo e passos de "Freestyle"** (ginástica de rua), muitas vezes espetaculares.

O Street Workout está em grande crescimento na Europa, com cada vez mais praticantes, homens e mulheres de todas as idades, de todos os níveis e são criadas várias Equipas para desenvolver esta aula. Frequentemente, os "**Workoutiers**" ou "**StreetWorkOuter**" praticam ainda os exercícios no mobiliário urbano

(bancos, candeeiros, postes, jogos de crianças, percursos desportivos, etc.). Deste modo, a **Husson** descobriu uma nova aula, há mais de 10 anos visto existirem equipamentos da gama Outdoor Fitness **Color'ado**® de primeira geração (1991!) , eram regularmente utilizados por "Workoutiers"!

Em colaboração com especialistas desportivos, associações de **Street Workout** e, especialmente, com a equipa "**BarStras**" de Strasbourg, a **Husson** foi, deste modo, uma das primeiras empresas a ter investido nesta nova aula, para propor os novos espaços de **Out&Fit®SWO**.

*a equipa "**BarStras**" com uma centena de membros participa com sucesso em competições de Street Workout a nível europeu



Out&Fit SWO

FORÇA, EQUILÍBRIO E DOMÍNIO CORPORAL







Com os nossos especialistas, concebemos as áreas **Out&Fit® SWO Pro** para os "StreetWorkOuter" de elite e as áreas **Out&Fit® SWO Training** para Todos, incluindo para os iniciantes e desportistas com mobilidade reduzida.

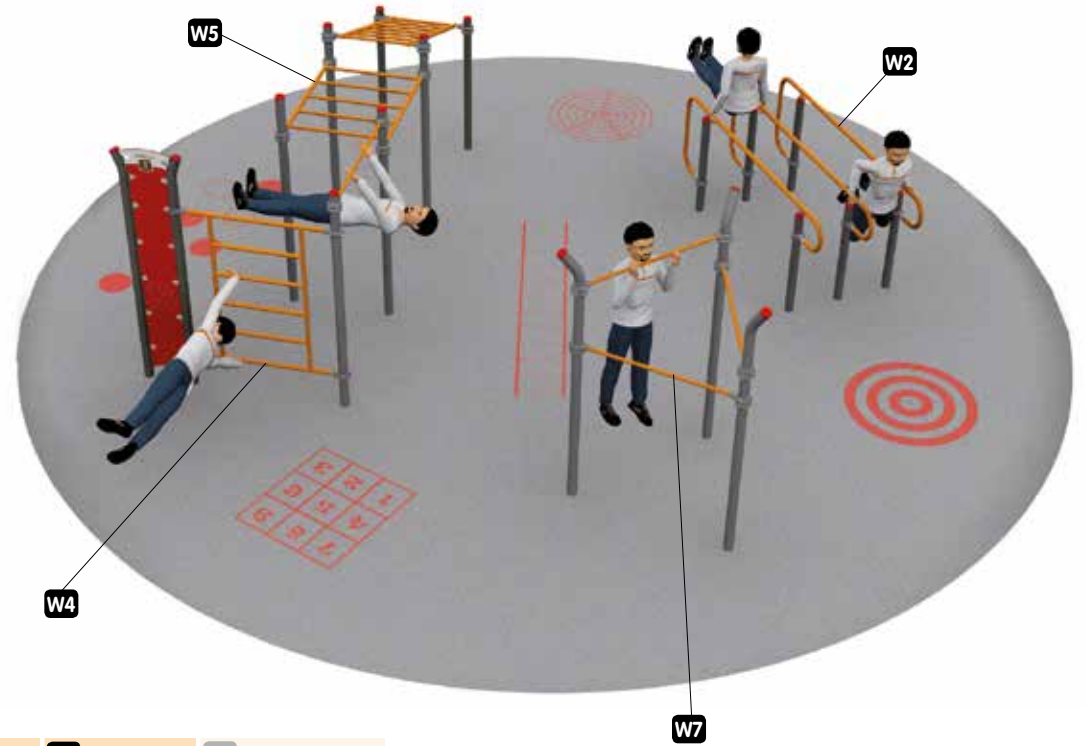

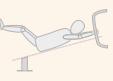
Out&Fit SWO JWO-0101

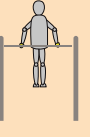
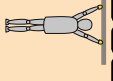
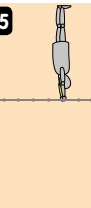
 Número de utilizadores 9	 Número de aparelhos 9	 Exercícios principais 20	 Exercícios adicionais Coaching Connect >36	 Total exercícios >56
---	--	---	--	--

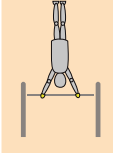

W1  Abdominais 0 0 >0	W2  Dips Bar 2 4 >5	W3  Trax Bar 3 5 >10	W4  Vertical Scale 1 2 >6	W5  Horizontal Scale 1 3 >6	W6  Inclined Scale 1 3 >6	W7  Push&Pull Bar 1 3 >3	W8  Para Dips 0 0 >0
--	---	--	--	---	--	--	--

 JWO0101		 14+	 7500 x 7500 2699 mm	 Ø 10 500 mm	 87 m ²	 2,3 m	 14h	 2	 -50 18
--	---	--	---	--	--	--	--	--	--

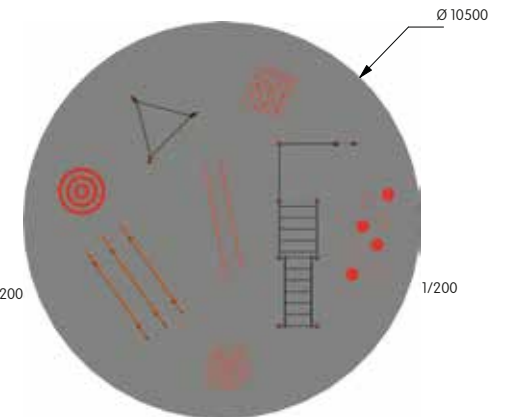
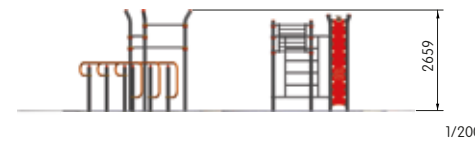

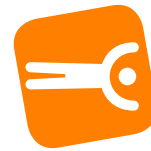

Out&Fit SWO JWO-0101







Além dos incontornáveis Dips Bar e Trax Bar, esta configuração **Out&Fit Street WorkOut** muito completa inclui igualmente uma arena equipada com 3 escadas (horizontal, vertical e inclinada), especialmente, adaptada a exercícios e passos Pro e Training. No total, esta configuração permite realizar mais de 55 exercícios, passos e coreografias.

Os **Out&Fit Street WorkOut** são totalmente modulares e adaptam-se ao local de instalação (mais de 30 módulos diferentes disponíveis). Não hesite em pedir ao seu responsável regional um estudo específico do seu projeto.

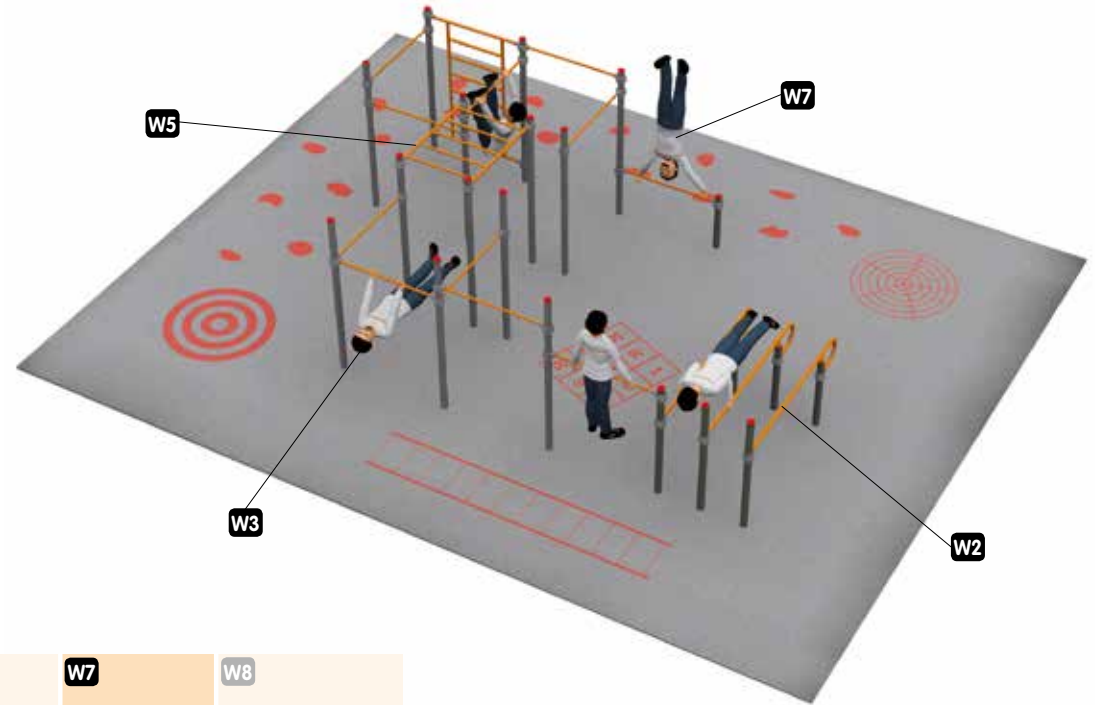



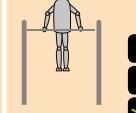
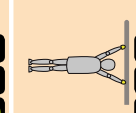
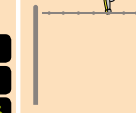
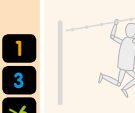
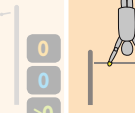



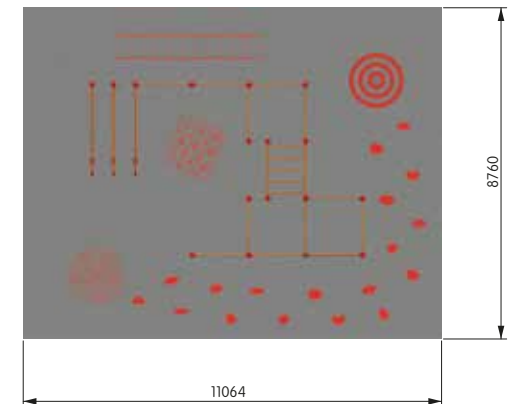
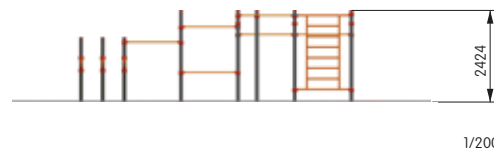

Out&Fit SWO JWO-0102

 Número de utilizadores 14	 Número de aparelhos 14	 Exercícios principais 17	 Exercícios adicionais Coaching Connect >30	 Total exercícios >47
--	---	---	--	--



W1  Abdominais 0 0 >0	W2  Dips Bar 2 4 >5	W3  Trax Bar 8 5 >10	W4  Vertical Scale 1 2 >6	W5  Horizontal Scale 1 3 >6	W6  Inclined Scale 0 0 >0	W7  Push&Pull Bar 2 3 >3	W8  Para Dips 0 0 >0
---	---	--	---	---	--	--	--



 JWO0102		 14+	 7200 x 5800 x 2424 mm	 11 064 x 8760 mm	 97 m ²	 2,3 m	 10h	 2	 -50 20
--	---	--	--	---	--	--	--	--	--



Out&Fit SWO JWO-0102





Uma configuração equipada com todos os aparelhos de base do **Out&Fit Street WorkOut** : Dips Bar, Trax Bar, Push&Pull Bar, Escadas vertical e horizontal. No total, esta configuração permite realizar mais de 46 exercícios, passos e coreografias.

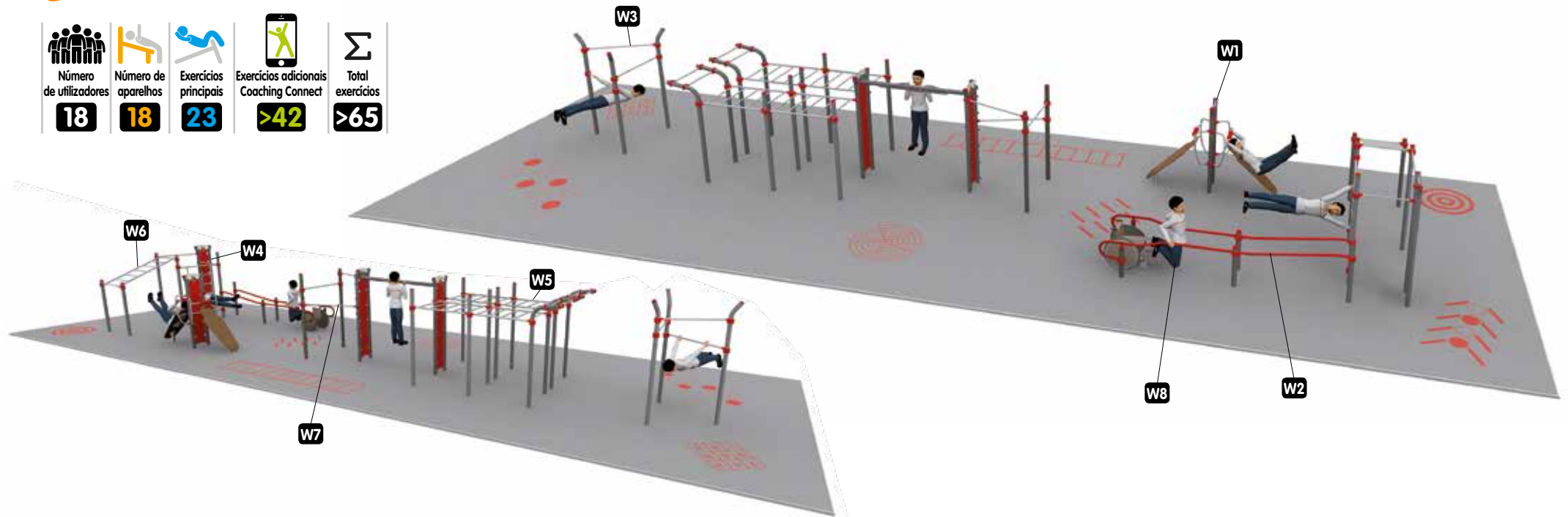

Out&Fit SWO JWO-0103

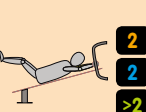
 Número de utilizadores 18	 Número de aparelhos 18	 Exercícios principais 23	 Exercícios adicionais Coaching Connect >42	 Total exercícios >65
--	---	---	--	--

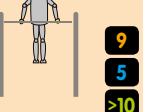
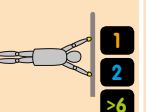

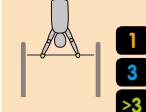
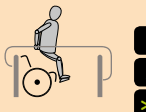







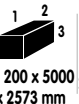

W1  Abdominais 2 2 >2	W2  Dips Bar 1 4 >5	W3  Trax Bar 9 5 >10	W4  Vertical Scale 1 2 >6	W5  Horizontal Scale 2 2 >6	W6  Inclined Scale 1 3 >6	W7  Push&Pull Bar 1 3 >3	W8  Para Dips 1 2 >4
---	---	--	---	---	--	--	--

Uma configuração **Out&Fit Street WorkOut** especialmente bem equipada. Vários aparelhos que permitem estabelecer uma área muito completa: várias TraxBar, pranchas abdominais, escadas verticais, horizontais e inclinadas.

Está igualmente equipado com um aparelho específico para as Pessoas com mobilidade reduzida (ParaDips). No total, esta configuração permite realizar mais de 65 exercícios, passos e coreografias.

Os **Out&Fit Street WorkOut** são totalmente modulares e adaptam-se ao local de instalação (mais de 30 módulos diferentes disponíveis). Não hesite em pedir ao seu responsável regional um estudo específico do seu projeto.

	 JWO0103		 14+	 18 200 x 5000 x 2573 mm	 22 000 x 7300 mm	 161 m ²	 2,3 m	 20h	 2	 -50 34
---	--	---	--	--	---	---	--	--	---	--

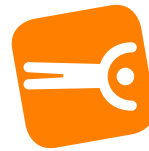

Out&Fit SWO JWO-0103

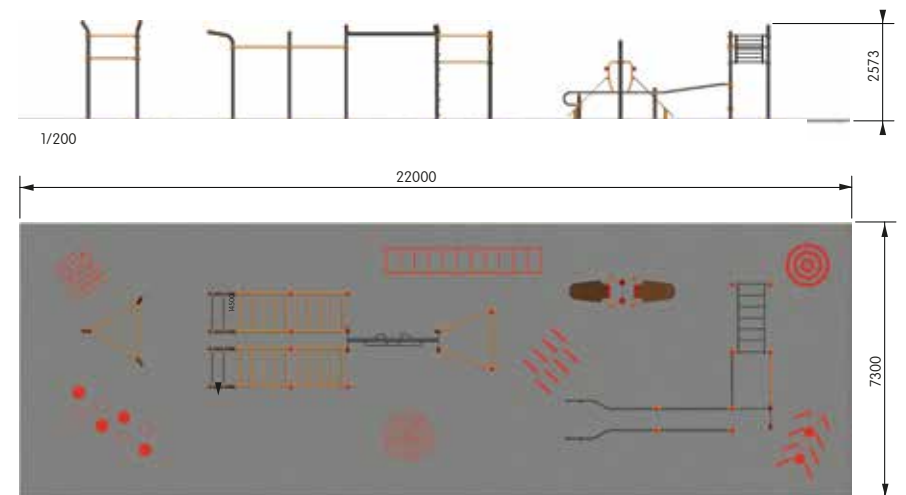







Out&Fit SWO JWO-0104

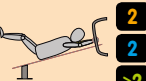

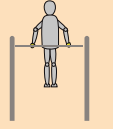
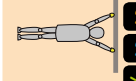
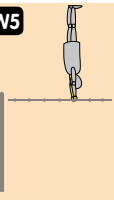

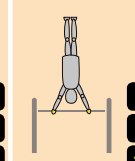
 Número de utilizadores 22	 Número de aparelhos 22	 Exercícios principais 21	 Exercícios adicionais Coaching Connect >38	 Total exercícios >59
--	---	---	--	--



Todos os aparelhos do **Out&Fit Street WorkOut** reunidos em 1 só configuração: TraxBar, Dips Bar, Abdominais, escadas verticais, horizontais e inclinadas, Push&Pull Bar, etc. No total, esta configuração permite realizar mais de 59 exercícios, passos e coreografias.

W1  Abdominais 2 2 >2	W2  Dips Bar 4 4 >5	W3  Trax Bar 8 5 >10	W4  Vertical Scale 2 2 >6	W5  Horizontal Scale 2 2 >6	W6  Inclined Scale 1 3 >6	W7  Push&Pull Bar 3 3 >3	W8  Para Dips 0 0 >0
--	---	--	--	---	---	--	--

Os **Out&Fit Street WorkOut** são totalmente modulares e adaptam-se ao local de instalação (mais de 30 módulos diferentes disponíveis). Não hesite em pedir ao seu responsável regional um estudo específico do seu projeto.

 JWO0104		 14+	 22 000 x 8700 x 3025 mm	 26 000 x 14 500 mm	 162 m ²	 2,3 m	 30h	 2	 -50 45
--	---	--	--	---	---	--	--	--	--



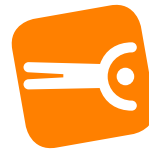

Out&Fit SWO JWO-0104

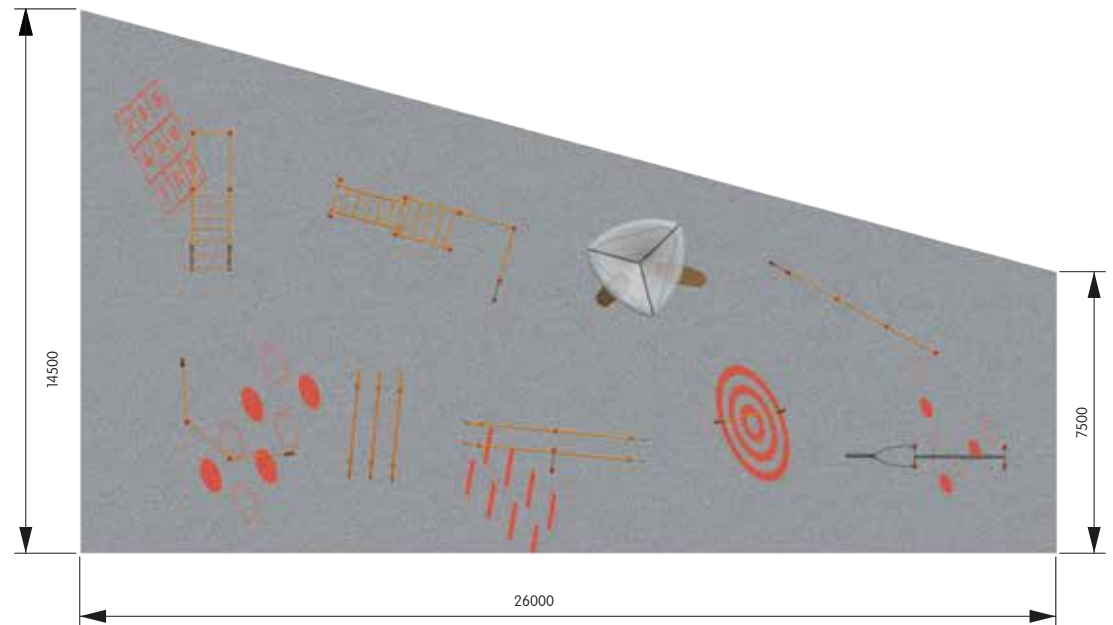



A organização de espaços para **pré-adolescentes e adolescentes** é relativamente recente e a Husson é uma das primeiras empresas a terem investido nesta problemática, há mais de ...25 anos!
Este público exigente e crítico, cheio de força e destreza, não deixa impor soluções padrão, reclama espaços muito bem identificados para evoluir livremente.

Color'ado® em todos os campos.

Graças a um trabalho de fundo e a vários testes de amplitude da natureza, os campos Multisports **Color'ado®** foram rapidamente concebidos e atingiram rapidamente a maturidade e, atualmente, são milhares de locais na Europa e nos outros continentes que abriram aos adolescentes as fronteiras do **Color'ado®**!

Grandes cidades urbanas, burgos ou aldeias, preencheram um vazio instalando verdadeiros polos de atração de desporto e lazer para os **pré-adolescentes e adolescentes**.





Um espaço mín., uma polivalência máx.:

Um Espaço MÍN., uma polivalência MÁX.: A partir de uma plataforma de apenas 24 x 13 metros, podemos entrar no jogo!

Mais de 20 desportos a praticar de acesso livre, no interior e exterior do recinto.

Color'ado® Multisports:

futebol, basquetebol, handebol, voleibol, badminton, futnet, quick soccer, roller-basket, cycle-ball ... e, opcional: roller-hockey, cricket, ténis, ping-pong, matraquilhos, Fitness, Stretching, Training, Street Workout, atletismo ...



Os campos Multisports Color'ado®

Um verdadeiro POLO DE ATRAÇÕES:

No meio da natureza ou no centro de um bairro, num local de lazer ou num campo de férias, os **Color'ado® Multisports** abrem novos espaços de liberdade, desporto e animação.

O LOCAL IDEAL para os pontos de encontro:

A ação favorece a troca, o convívio, o prazer de estar juntos. Os pré-adolescentes e adolescentes, raparigas e rapazes vão adorar o **Color'ado® Multisports** ... e quando gostam, respeitam!

O incentivo da ATIVIDADE FÍSICA:

Para diminuir o risco de obesidade nas crianças e adolescentes, todos os especialistas de saúde incentivam a atividade física. Ao instalar um espaço polidesportivo, inspiramo-los a...
FAZER DESPORTO!

O espírito "FAIR-PLAY":

Segundo a opinião dos especialistas, o desporto é para os jovens a antiviolença e um trampolim para a idade adulta. No campo ou entre jogadores e espetadores, o **Color'ado® Multisports** institui os valores do desporto num espírito "Fair-play".





Um investimento **VENCEDOR:**

Custo inicial muito razoável, longevidade excepcional, despesas de funcionamento insignificantes, etc.
A garantia de um investimento vencedor e aprovado por **TODOS**: pré-adolescentes, adolescentes e adultos.

Um design muito **DESPORTIVO:**

Imaginado com os adolescentes, para adolescentes, os designers conceberam uma linha dinâmica com estilo desportivo.

Uma perfeita integração no **MEIO-AMBIENTE:**















Os designers escolheram a transparência com painéis transparentes exclusivos* e temas com cores harmoniosas: "Park", "Urban", "Sport"...



color'ado Multisports JCN-0021











 Número de utilizadores >16	 Número de atividades de base 8	 Atividades adicionais 5	 Total atividades 13
--	---	--	--



M1  1	M2  1	M3  1	M4  1	M5  1	M6  1	M7  1	M8  1	M9   2	M10   0	M11   3
Futebol	Basquetebol	Handebol	Voleibol	Badminton	Futnet	Roller Basket	Cycle-Ball	OPÇÕES desporto interior Recinto	OPÇÕES desporto exterior Recinto	OPÇÕES pontos de encontro Exterior Recinto

OPÇÕES ADICIONAIS

- M9** 2 pares minibalizas
- M11** 2 sentados-de pé
1 acesso para pessoas com mobilidade reduzida

	 JCN0021		 7+	 25 000 x 12 300 x 3050 mm	 25 600 x 13 900 mm	 286 m ²	 0 m	 12h	 3	 -50 / 40
---	--	---	---	--	---	---	--	--	--	---

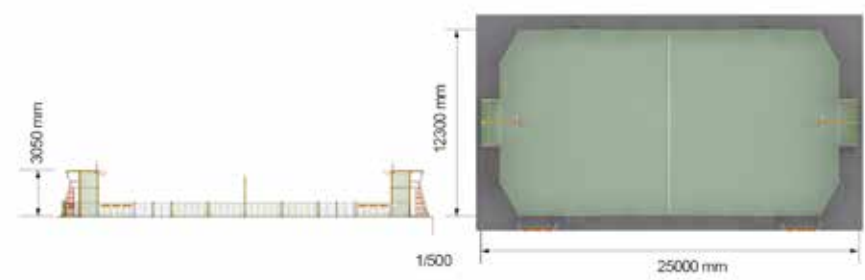







O campo Multisports **Color'ado**® JCN-021 em metal "25 x 12", na versão painéis "Concept" que privilegiam a transparência e uma boa integração no meio-ambiente. Muito bem equipado, com atividades adicionais no interior do recinto (1 par de balizas pequenas) e no exterior (2 sentados/de pê).

Outras atividades, temas, cores:















Consultar as páginas de apresentação **Color'ado**® e peça conselhos ao seu responsável regional.



color'ado Multisports JCN-0023











 Número de utilizadores >14	 Número de atividades de base 8	 Atividades adicionais 5	 Total atividades 13
--	---	--	--



M1  1	M2  1	M3  1	M4  1	M5  1	M6  1	M7  1	M8  1	M9   2	M10   1	M11   2
Futebol	Basquetebol	Handebol	Voleibol	Badminton	Futnet	Roller Basket	Cycle-Ball	OPÇÕES desporto interior Recinto	OPÇÕES desporto exterior Recinto	OPÇÕES pontos de encontro Exterior Recinto

OPÇÕES ADICIONAIS

- M9** 2 pares minibalizas
- M10** 1 cesto de basquetebol no exterior
- M11** 1 suporte de estacionamento para bicicletas
1 acesso para pessoas com mobilidade reduzida

	 JCN0023		 7+	 22 400 x 12 300 x 3050 mm	 29 000 x 13 900 mm	 251 m ²	 0 m	 16h	 3	 -50 38
---	--	---	---	--	---	---	--	--	--	--

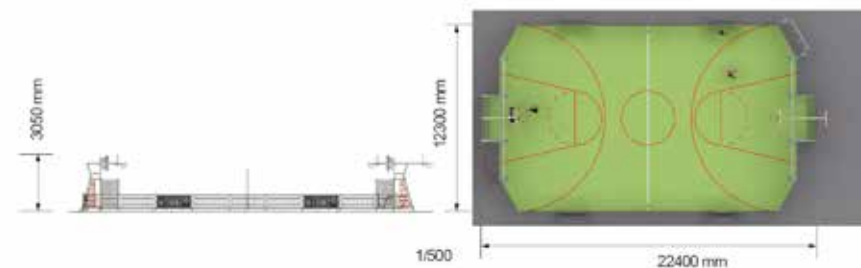

color'ado Multisports JCN-0023





JCN-0023 em metal 22 x 12

O campo Multisports **Color'ado**® JCN-0023 em metal "22 x 12", na versão painéis "Silent". Um sistema único antichoque e antirruido, extremamente robusto e silencioso. Muito bem equipado, com atividades adicionais no interior do recinto (2 pares de balizas pequenas, 1 rede multifunções) e no exterior (1 cesto de basquetebol). Integra igualmente um novo design de frontão apresentado no tema Sport.











Outras atividades, temas, cores:

Consultar as páginas de apresentação **Color'ado**® e peça conselhos ao seu responsável regional.

color'ado Multisports JCN-0020











 Número de utilizadores >10	 Número de atividades de base 8	 Atividades adicionais 1	 Total atividades 9
--	---	--	---



M1  1	M2  1	M3  1	M4  1	M5  1	M6  1	M7  1	M8  1	M9  0	M10  0	M11  1
Futebol	Basquetebol	Handebol	Voleibol	Badminton	Futnet	Roller Basket	Cycle-Ball	OPÇÕES desporto interior Recinto	OPÇÕES desporto exterior Recinto	OPÇÕES pontos de encontro Exterior Recinto 1 acesso para pessoas com mobilidade reduzida

OPÇÕES ADICIONAIS

M11 1 acesso para pessoas com mobilidade reduzida

	JCN0020		 7+	 22 400 x 12 300 x 3051 mm	 23 000 x 12 900 mm	 252 m ²	 0 m	 16h	 3	 -50 / 34
---	---------	---	---	--	---	---	--	--	--	---

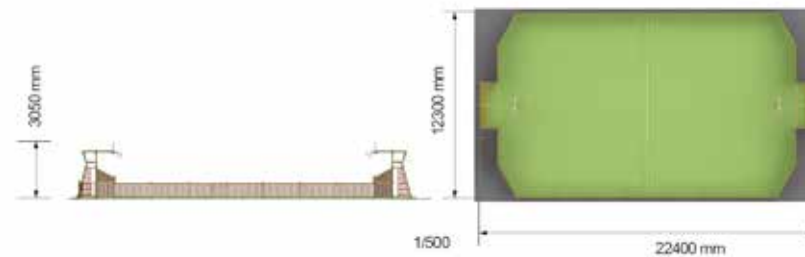

color'ado Multisports JCN-0020







O campo Multisports **Color'ado**® JCN-0020 na versão mista madeira/metal com todas as vantagens das estruturas Color'ado: solidez, segurança, capacidade de evolução e design natural. Os painéis em madeira estão disponíveis em 2 versões: madeira resinosa ou madeira compósita reciclada. Muito bem equipado de base, com 1 atividade adicional no exterior do recinto (1 cesto de basquetebol).















Outras atividades, temas, cores:

Consultar as páginas de apresentação **Color'ado**® e peça conselhos ao seu responsável regional.

color'ado Multisports JCN-0022

 Número de utilizadores >10	 Número de atividades de base 8	 Atividades adicionais 2	 Total atividades 10
--	---	--	--



M1  1	M2  1	M3  1	M4  1	M5  1	M6  1	M7  1	M8  1	M9   2	M10   0	M11   0
Futebol	Basquetebol	Handebol	Voleibol	Badminton	Futnet	Roller Basket	Cycle-Ball	OPÇÕES desporto interior Recinto	OPÇÕES desporto exterior Recinto	OPÇÕES pontos de encontro Exterior Recinto

OPÇÕES ADICIONAIS

M9 2 pares minibalizas

	 JCN0022		 7+	 20 550 x 11 340 x 3 050 mm	 21 100 x 12 900 mm	 218 m ²	 0 m	 12h	 3	 -50 / 30
---	--	---	---	---	---	---	--	--	--	---

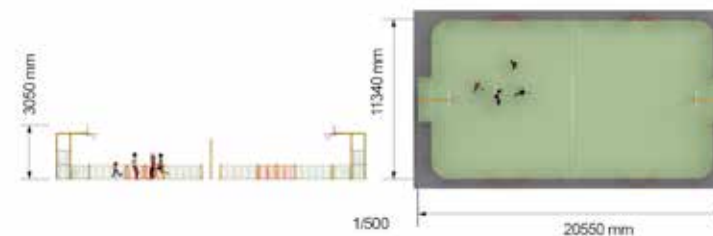

color'ado Multisports JCN-0022



JCN-0022 em metal 20,5 x 11

O campo Multisports **Color'ado**® JCN-022 em metal "20,5 x 11", na versão painéis e balizas "Concept" que privilegiam a transparência. Uma versão reduzida com todas as atividades desportivas indispensáveis.















Outras atividades, temas, cores:

Consultar as páginas de apresentação **Color'ado**® e peça conselhos ao seu responsável regional.

color'ado Multisports JCN-0024

 Número de utilizadores >14	 Número de atividades de base 8	 Atividades adicionais 7	 Total atividades 15
--	---	--	--













M1  1 Futebol	M2  1 Basquetebol	M3  1 Handebol	M4  1 Voleibol	M5  1 Badminton	M6  1 Futnet	M7  1 Roller Basket	M8  1 Cycle-Ball	M9   3 OPÇÕES desporto interior Recinto	M10   1 OPÇÕES desporto exterior Recinto	M11   3 OPÇÕES pontos de encontro Exterior Recinto
--	--	---	---	--	---	--	---	---	--	--

OPÇÕES ADICIONAIS

- M9** 2 pares minibalizas
- 1 mini cesto de basquetebol
- M10** 1 cesto de basquetebol no exterior
- M11** 2 bancadas cobertas
- 1 acesso para pessoas com mobilidade reduzida

Outros aparelhos
 Out&Fit Gym JFI-0101
 Out&Fit Ski Training JFI-0901
 Out&Fit SWO JWO-0101

	 JCN0024		 7+	 1 2 3 22 400 x 12 300 x 3050 mm	 44 000 x 21 000 mm	 m ² 251 m ²	 0 m	 40h	 3	 -50 65
---	---	---	--	--	--	---	---	---	---	--

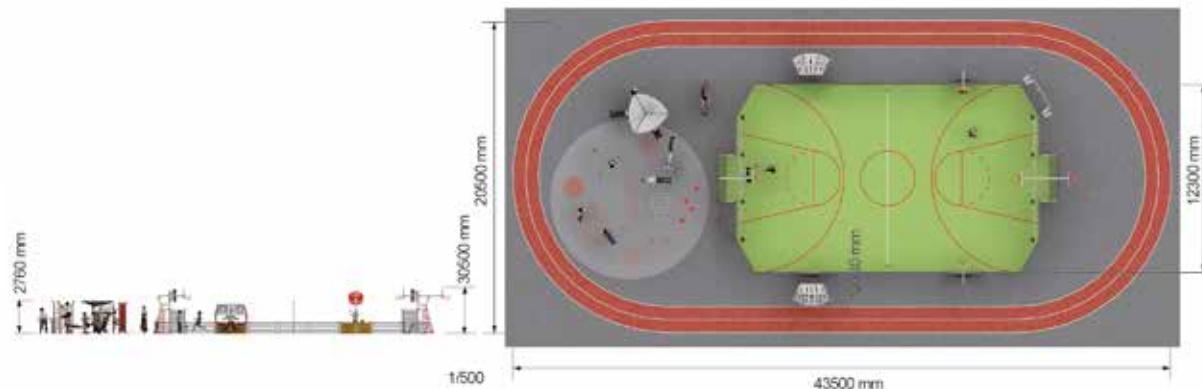



color'ado Multisports JCN-0024



A disposição do JCN-0024 é um espaço desportivo global: Multisports **Color'ado**®, StreetWorkout, Out&Fit Gym e Training.

Um verdadeiro polo desportivo!





Todas as opções, com atividades adicionais no interior do recinto (2 pares de balizas pequenas, postes multifunções, mini-cestos de basquetebol) e no exterior (abrigo jogadores, cesto de basquetebol traseiro, suporte de estacionamento para bicicletas, StreetWorkOut, Fitness, Ski-Training, etc.).

Outras atividades, temas, cores:

Consultar as páginas de apresentação **Color'ado**® e pedir conselhos ao seu responsável regional.



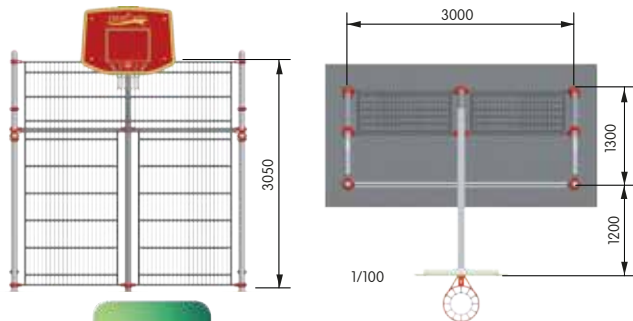
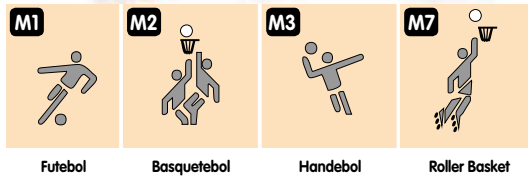

Os multisports **Color'ado**® são totalmente modulares e adaptam-se ao local de instalação (dimensões, alturas, opções, etc.). Não hesite em pedir ao seu responsável regional um estudo específico do seu projeto.

JCN-0012 Baliza Multisports "Silent"

 Número de utilizadores	 Número de actividades de base	 Actividades adicionales	 Total actividades
>5	4	0	4





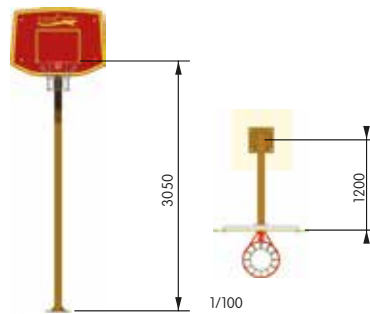
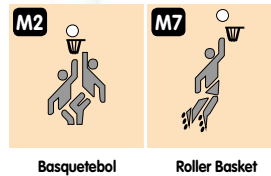

JCN-0265 PlayGround

 Número de utilizadores	 Número de actividades de base	 Actividades adicionales	 Total actividades
>4	2	0	2





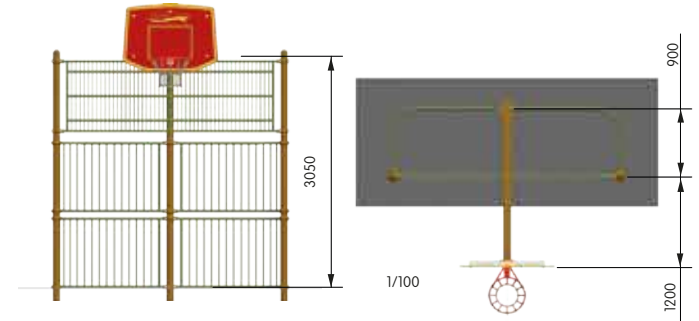
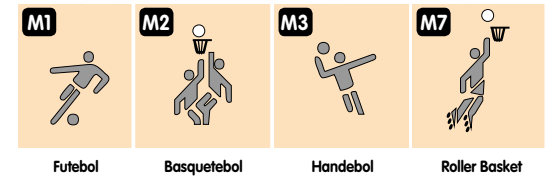

JCN-0018 Baliza Multisports "Concept"





 Número de utilizadores	 Número de actividades de base	 Actividades adicionales	 Total actividades
>5	4	0	4

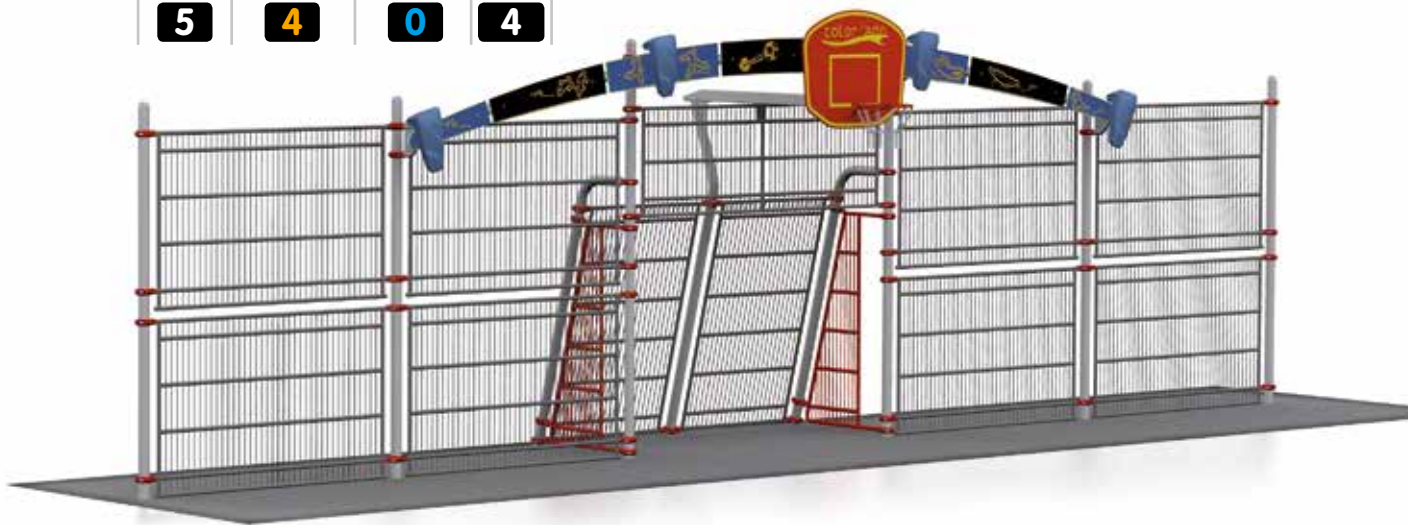

JCN-0019 Frontão 13 m

			
Número de utilizadores	Número de atividades de base	Atividades adicionais	Total atividades
5	4	0	4



M1 	M2 	M3 	M7 
Futebol	Basquetebol	Handebol	Roller Basket

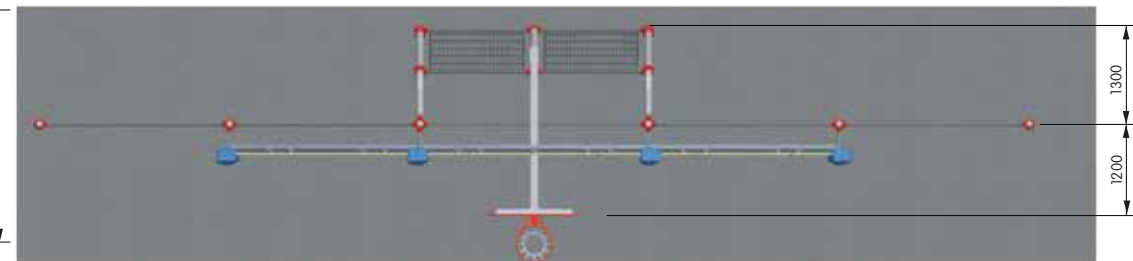
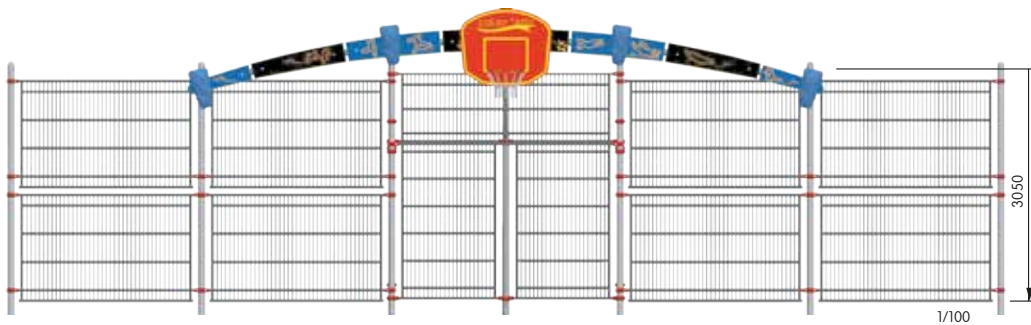

color'ado

Multisports coberto



365 dias por ano



color'ado Multisports coberto

- **Não passo um dia sem o meu Multisports!**

Os **Color'ado® Multisports Cobertos** incentivam a prática dos desportos coletivos, bem como outras manifestações desportivas e culturais, 365 dias por ano!

- **Todas as vantagens do ar livre sem os inconvenientes:**

A cobertura especial dos **Color'ado® Multisports** volta a dar otimismo nos dias de chuva e tonificação nos dias de sol.

- **Um design excelente e exclusivo*** com formas arredondadas e suaves.

- **Uma qualidade de jogo total:** a cobertura transparente garante a claridade e uma ventilação natural

- **Um investimento ideal:** muito económico em comparação com outros equipamentos (campo de futebol, ginásio, etc.)

- Um conceito modular e evolutivo: que permite adaptar um **Color'ado® Multisports** Coberto a quase todos os locais, meios-ambientes e orçamentos. É igualmente possível considerar a instalação em várias fases.

*modelos registados, sistemas patenteados



As Melhores Técnicas:

1. Um conceito construtivo inovador:

- a cobertura **Color'ado**® é constituída por uma estrutura em aço-alumínio e uma membrana em têxtil esticada.
- os postes laterais da estrutura fazem parte da estrutura do complexo polidesportivo coberto (sem sobreposição de postes nem elementos salientes).
- os 2 módulos de cobertura na extremidade garantem o contraventamento do conjunto (sem vigas metálicas nem cruz de santo andré, etc.)
- a membrana em tecido esticada reúne todas as vantagens: transparência, acústica e limpeza automática.

2. Uma solidez excepcional: graças a uma estrutura em aço galvanizado e alumínio.

3. Uma garantia de 10 anos da estrutura metálica.

4. Uma segurança total:

o conjunto da estrutura está em conformidade com as regras NV65 e pronta a resistir às regiões mais ventosas (classificadas zona 3).





5. O incentivo do desenvolvimento sustentável:

com a utilização de materiais reconhecidos pela sua durabilidade como o aço, o alumínio e a membrana têxtil.











*modelos registados, sistemas patenteados















 Número de utilizadores	 Número de atividades de base	 Atividades adicionais	 Total atividades
10	8	0	8



M1  1	M2  1	M3  1	M4  1	M5  1	M6  1	M7  1	M8  1	M9  0	M10  0	M11  0
Futebol	Basquetebol	Handebol	Voleibol	Badminton	Futnet	Roller Basket	Cycle-Ball	OPÇÕES desporto interior Recinto	OPÇÕES desporto exterior Recinto	OPÇÕES pontos de encontro Exterior Recinto

Complexos polidesportivos com zona de jogo coberta e 2 espaços cobertos nas extremidades que permitem fazer atividades adicionais (animações desportivas e culturais)

										
JCN0500			7+	27 988 x 16 480 x 7000 mm	29 000 x 13 600 mm	268 m ²	0 m	40h	3	+00 38

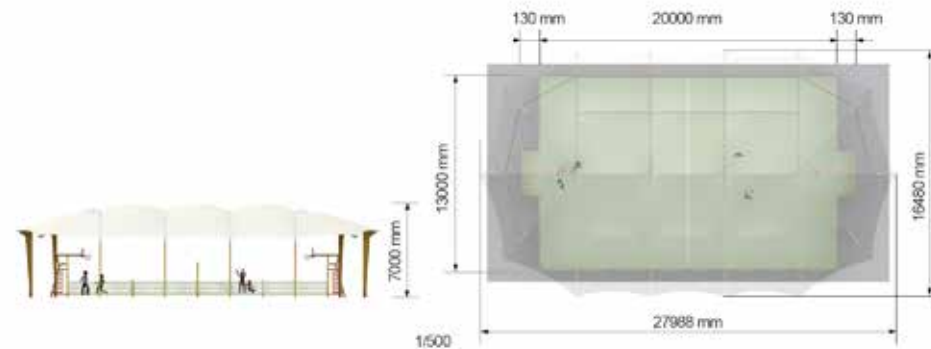

color'ado Multisports coberto JCN-0500

O campo Multisports **Color'ado**® Coberto **JCN-0500** inclui todas as atividades desportivas indispensáveis. 2 grandes espaços cobertos na traseira das 2 balizas que permitem fazer atividades adicionais (animações desportivas e culturais, atividades extracurriculares, etc.) Os multisports **Color'ado**® são totalmente modulares e adaptam-se ao local de instalação (dimensões, alturas, opções, ...).

Não hesite em pedir ao seu responsável regional um estudo específico do seu projeto



color'ado



Meeting Point

"Aqui começa o nosso mundo"

"Um local bem nosso", uma reivindicação mil vezes expressa...mas nem sempre ouvida!
Portanto, corresponde a uma verdadeira necessidade dos adolescentes, "encontrarem-se entre eles".





Os designers HUSSON criaram os Color'ado® Meeting Point especialmente para os 12-17 anos. Uma linha original de mobiliário e abrigos.

- Adotado, batizado, respeitado... muito rapidamente, os adolescentes identificam "o seu" ponto de encontro, tanto abrigado como aberto, original e ergonómico.
- Estilo, cor, ergonomia: é o trio vencedor que agrada aos adolescentes.
- A robustez excepcional é garantida pela utilização dos melhores materiais como o aço galvanizado e o inox para os elementos de armação.
- Uma manutenção simples e muito económica.

*Modelos registados, sistemas patenteados

color'ado Meeting Point

JME-0001
Assento folha

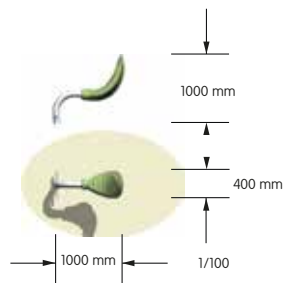

A folha Color'ado® Meeting Point, com design exclusivo*, oferece-lhe uma solução de organização única com um forte poder de integração e de sedução.



JME-0009 Bancada aberta

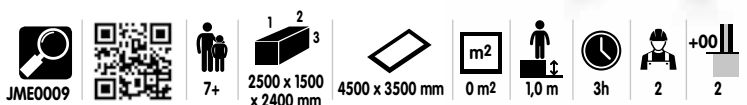
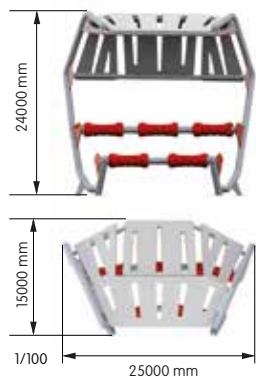

JME-0010 Bancada

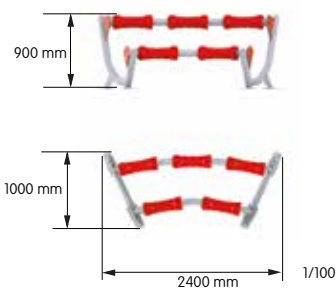

Se a primeira vocação de uma bancada é acolher espectadores, os praticantes demonstraram-nos que, por vezes, é igualmente o local a que os desportistas recorrem, antes e depois do esforço, para exercícios de ...stretching!

Os designers HUSSON reviram portanto esta função para conceber novos mobiliários originais e notavelmente bem adaptados aos adolescentes. Associados a um complexo polidesportivo, uma baliza, um espaço Fitness, a mesas de ping-pong de exterior ou até matraquilhos, **a minibancada Color'ado®** completa idealmente a sua organização desportiva.

color'ado Meeting Point



JME-0004
Abrigo 1



Para outros temas, cores e aparelhos: consultar as páginas de apresentação Out&Fit e peça conselhos ao seu responsável regional.

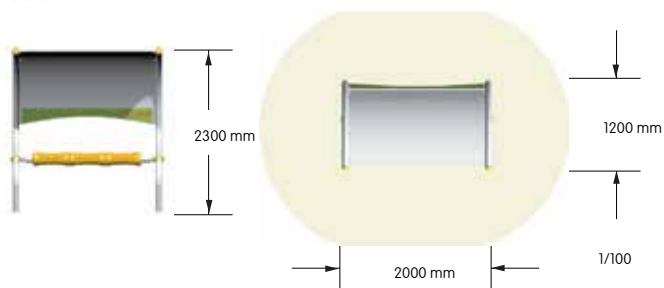

 JME0004		 7+	 2000 x 1200 x 2300 mm	 4000 x 3000 mm	 0 m²	 0,5 m	 2h	 2	 +00 2
--	---	---	--	---	---	--	---	--	---



color'ado Meeting Point

JME-0005
Abrigo 2

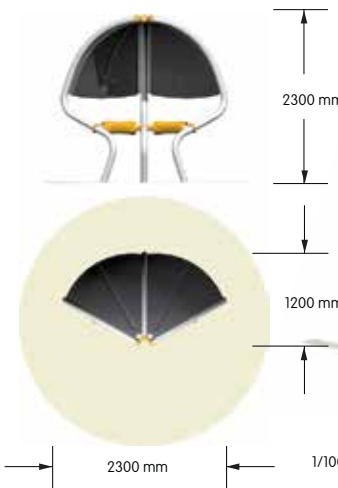

Os abrigos Color'ado® Meeting Point são configuráveis e concebidos para satisfazer, da melhor forma, a sua necessidade de disposição. Módulos únicos ou associados, constituem um conjunto de convívio muito apreciado pelos adolescentes que têm uma necessidade natural de se juntarem para conversar.

Outras atividades, temas, cores: Peça conselhos ao seu responsável regional.



JME0005		7+	1 2 3 2300 x 1200 x 2300 mm	3200 x 3200 mm	0 m²	0,5 m	2h	2	3
---------	--	----	--------------------------------	----------------	------	-------	----	---	---



Husson é também...    



HUSSON International s.a.

Uma solidez lendária

ROUTE DE L'EUROPE
B. P. N°1 - 68650 LAPOUTROIE - FRANÇA
TEL.: +33 3 89 47 56 56 - FAX: +33 3 89 47 26 03
www.husson.eu - E-mail: husson@husson.eu

